

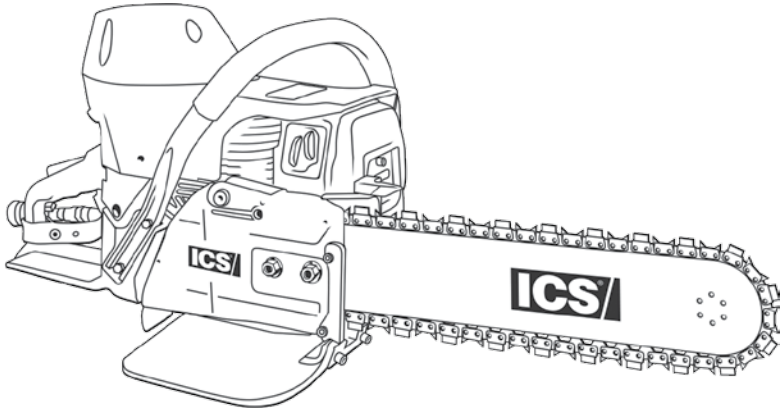

**Diamond Tools and Equipment
for Construction and Infrastructure**



680ES

OPERATOR MANUAL

**WARNING: READ AND UNDERSTAND ALL SAFETY WARNINGS
AND ALL INSTRUCTIONS BEFORE YOU USE THIS EQUIPMENT.**

Failure to follow the warnings and instructions may result in fire, serious injury, or death.

SAVE ALL WARNINGS AND INSTRUCTIONS FOR FUTURE REFERENCE

Original Document

This instruction manual contains translations of a manual drafted in English and are provided to assist those who do not speak English as their first language. Being a technical writing, some terms may not have a like or equivalent meaning as translated. Therefore, you should not rely on this translation, and should cross-reference the English version, where relying on the translated instructions could result in harm to your person or property.

TABLE OF CONTENTS

| | |
|-----------------------------------|-----------|
| SYMBOLS AND LABELS | 4 |
| ICS 680ES NAMES AND TERMS | 7 |
| PRODUCT IDENTIFICATION | 9 |
| INTRODUCTION | 10 |
| SAFETY RULES | 11 |
| UNPACKING AND ASSEMBLY | 15 |
| FUELING | 22 |
| OPERATION | 25 |
| TRANSPORTING & STORING | 36 |
| MAINTENANCE | 37 |
| TROUBLESHOOTING | 45 |
| REFERENCE | 46 |
| EMISSIONS | 47 |
| TECHNICAL SPECIFICATIONS | 49 |
| SERVICE CENTERS | 50 |
| DECLARATION OF CONFORMITY | 51 |

SYMBOLS AND LABELS

THE FOLLOWING SYMBOLS ARE FOUND THROUGHOUT THIS MANUAL AND/OR ON THE SAW AND ARE DESIGNED TO MAKE YOU AWARE OF POTENTIAL HAZARDS OR UNSAFE PRACTICES.



SAFETY ALERT

Indicates that the text that follows explains a danger, warning or caution.



READ INSTRUCTIONS

The original instruction manual contains important safety and operating information. Read and follow the instructions carefully.



WEAR EYE, HEARING AND RESPIRATORY PROTECTION WEAR HEAD PROTECTION

Wear eye, hearing and respiratory protection and a protective helmet when operating the saw.



WEAR LONG PANTS

Wear long pants when operating the saw.



WEAR FOOT PROTECTION

Wear appropriate closed-toe boots when operating the saw.



WEAR HAND PROTECTION

Wear hand protection when operating the saw.



KERF WIDTH

Do not insert tool into slot narrower than chain.



VENTILLATION REQUIRED

Use tool in a well ventilated area

SYMBOLS AND LABELS

THE FOLLOWING SYMBOLS ARE FOUND THROUGHOUT THIS MANUAL AND/OR ON THE SAW AND ARE DESIGNED TO MAKE YOU AWARE OF POTENTIAL HAZARDS OR UNSAFE PRACTICES.



SOUND POWER

Sound power level is 117 dB(A).



BEWARE OF KICKBACK

Kickback can cause severe injuries.



TWO-HANDED HOLD

Operate the saw with two hands, securely gripping both handles



ONE-HANDED HOLD

Do not operate the saw with one hand.



DO NOT USE A LADDER

Never stand on a ladder when using the saw.



FIRE DANGER

Risk of fire if warnings not followed.



SLIPPERY SURFACE

Unsure footing can lead to accidents.

LABELS ON YOUR SAW

SAFETY LABEL

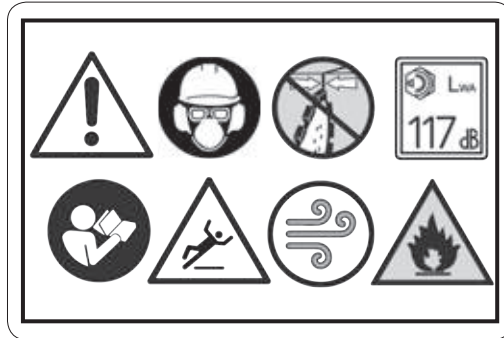

EMISSIONS LABELS



LABELS SHOWN FOR REFERENCE ONLY



NAMEPLATE LABEL

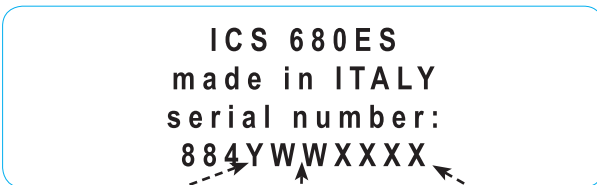

Y = Last Digit of the year the saw was built

WW = Week number within the year

XXXX = Indicates the saw number within production series

ICS 680ES NAMES AND TERMS

Air box intake

The only entry point of air into the engine

Bar pad

The mounting pad on the powerhead that helps assure proper alignment of the guidebar.

Bar slot

The slot feature on the guidebar that fits over the bar studs.

Bystander safety zone

A 6 m (20 ft) circle around the operator that must remain free from bystanders, children and pets.

Chain catcher

A device for retaining the chain if it breaks or derails.

Chain pitch

The distance between any three consecutive rivets on the chain divided by two.

Chain tensioning screw

An adjustment screw used to set proper tension on the chain and compensate for chain stretch from normal use.

Front handle

The support handle located at or toward the front of the saw intended to be gripped by the left hand.

Guidebar

A railed structure that supports and guides the chain. Sometimes simply called the "bar".

Kickback

The rapid backward and/or upward motion of the guidebar, occurring when the chain near the top area of the nose of the guidebar contacts a foreign object or snags in the workpiece.

Multi-function lever

A device for setting the choke and temporarily advancing the throttle in a partially open position to aid starting, allows the engine to run or causes the engine to stop.

Mud flap

A barrier to protect the operator from cutting debris and other projectiles.

ICS680ES NAMES AND TERMS

Powerhead

A saw without the chain or guidebar.

Pushback

The rapid backward motion of the guidebar, occurring when the chain on the top straight portion of the guidebar contacts a foreign object or snags in the workpiece.

Rear handle

The support handle located at or toward the rear of the saw intended to be gripped by the right hand.

Rear hand guard:

A structural barrier at the bottom right side of the rear handle to protect the operator in case the chain breaks or derails.

Side cover:

The component on the powerhead that covers the drive sprocket and directs debris away from the operator during use.

Side cover nuts:

The components on the side cover that secure the side cover and guidebar.

Throttle trigger lock-out

A device that prevents the unintentional operation of the throttle trigger until manually released.

Throttle trigger

A mechanism that controls engine RPM.

WallWalker®

A device used as a fulcrum to provide mechanical advantage during cutting.

Water shut-off valve

A mechanism that controls water delivery and flow to the guidebar and chain.

PRODUCT IDENTIFICATION

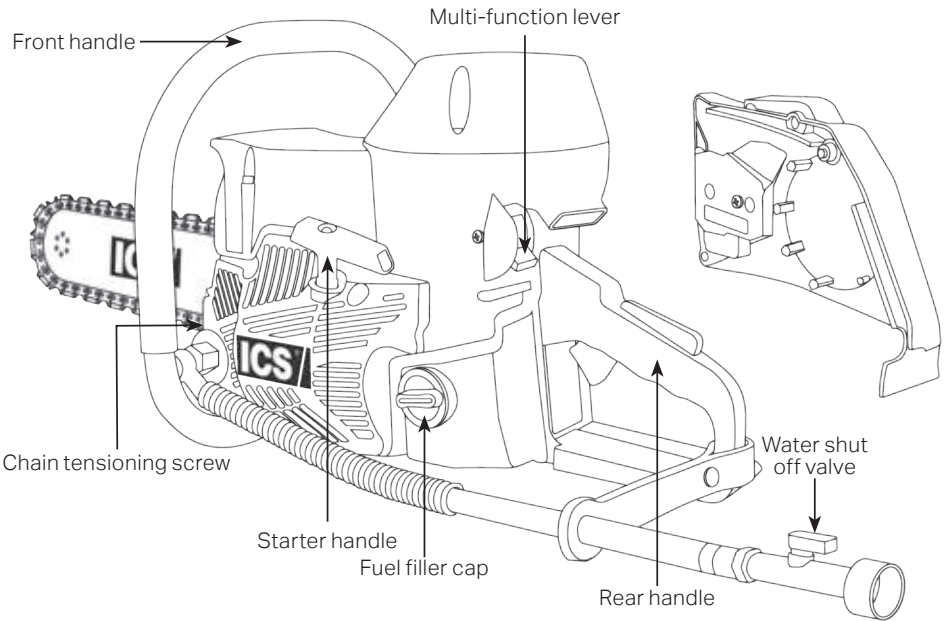
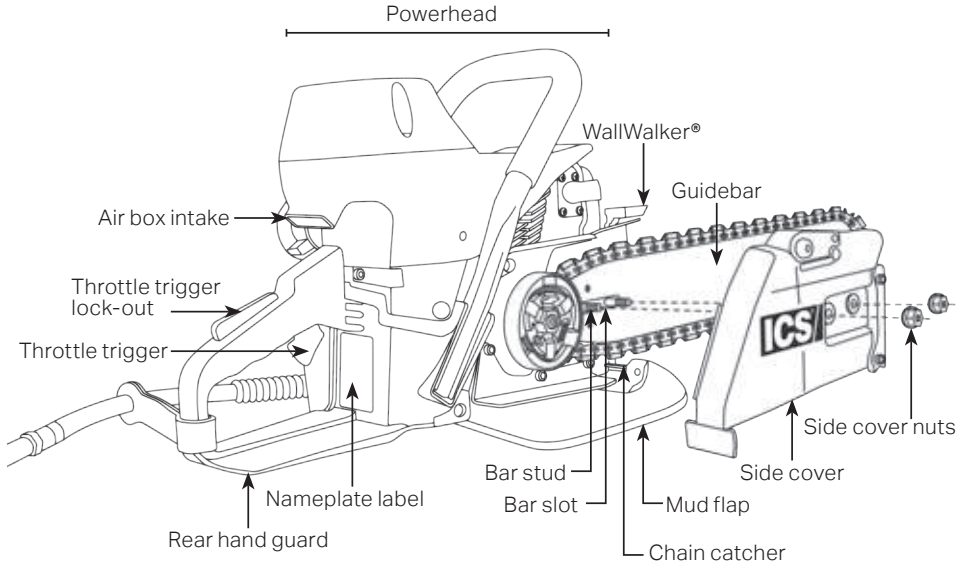

INTRODUCTION

The 680ES saw is designed to cut concrete, stone, and masonry when used with the appropriate genuine ICS Diamond Chain. This is a professional tool and is solely intended for use by trained and experienced operators. A first time operator should obtain practical instruction before using the saw, as well as reading and understanding this Operator's Manual.

Local legislation and/or workplace standards may regulate the use of this saw. Determine what regulations are applicable in the place you work before using the saw.

Prop 65 statement:

California Proposition 65 (the Safe Drinking Water and Toxic Enforcement Act of 1986) refers to the California legislation that was intended by its authors to protect California citizens and the State's drinking water sources from chemicals known to cause cancer, birth defects or other reproductive harm, and to inform citizens about exposures to such chemicals. Proposition 65 requires businesses to notify Californians about significant amounts of chemicals in the products they purchase, in their homes or workplaces, or that are released into the environment. By providing this information, Proposition 65 enables Californians to make informed decisions about protecting themselves from exposure to these chemicals. Proposition 65 also prohibits California businesses from knowingly discharging significant amounts of listed chemicals into sources of drinking water.

The engine exhaust from this machine and some types of dust/debris created from its normal operation may contain chemicals known to the State of California to cause cancer, birth defects, or other reproductive harm.

SAFETY RULES

To get the maximum benefit from your saw, and assure maximum safety, be sure to read this manual thoroughly and follow the safety instructions provided.

EXPLANATION OF WARNING LEVELS** DANGER**

Indicates a hazard with a high level of risk which, if not avoided, will result in death or serious injury.

 WARNING

Indicates a hazard with a medium level of risk which, if not avoided, could result in death or serious injury.

 CAUTION

Indicates a hazard with a low level of risk which, if not avoided, could result in minor or moderate injury.

IMPORTANT

Indicates a potential situation exists which, if not avoided, may result in damage to your saw or property.

HANDLING FUEL SAFELY

WARNING

Fuel vapors are highly flammable.

Turn off the saw, assure that the multi-function lever is set in the “STOP” position, and allow the engine to cool a few minutes before fueling. Do not smoke or refuel the saw in close proximity to any ignition sources. Move the saw at least 3 m (10 ft) from the fueling area before restarting it.

Avoid spilling fuel on yourself or on the saw.

Use only approved containers to transport and store fuel. If fuel is spilled on the saw, wipe up the spillage and allow the rest to evaporate. If fuel is spilled on yourself or your clothes, immediately remove contaminated clothing and wash any part of your body that has contacted fuel with soap and warm water.

CAUTION

Check saw for fuel leaks before starting.

Check regularly for leaks from the fuel cap and fuel lines and do not start saw if any leaks are found.

WORK AREA SAFETY

Following are the basic instructions to assure work area safety.

DANGER

Breathing exhaust gases can cause asphyxiation and carbon monoxide poisoning in high concentrations.

Use the saw only in a well-ventilated area.

WARNING

Drugs or alcohol can impair vision, dexterity, and judgment.

Do not operate the saw when tired or under the influence of any substance.

CAUTION

Remove or control slurry to prevent slippery conditions while cutting.

This saw uses water and can cause slippery surfaces due to the slurry produced and/or freezing temperatures.

Keep children and bystanders away from work area.

Set up a well-marked safety zone with a roped boundary and clear signs to keep bystanders at least 6 m (20 ft) away.

PERSONAL SAFETY

Following are the basic instructions to assure personal safety.

WARNING

Always wear protective clothing.

At a minimum always wear eye protection and/or face shield, hearing protection, long sleeve shirt, long pants, closed toe shoes with non-slip soles, and gloves. In many work situations, a hard hat and steel toed shoes may also be required. Avoid loose fitting clothing.

Long-term exposure to noise can result in permanent hearing impairment.

Always wear approved hearing protection.

This saw can generate hazardous dust and vapors.

Determine the nature of the material you are going to cut before proceeding with the job. Be especially aware of cutting materials containing silica and asbestos as inhaling dust can result in respiratory disease. Be sure to use appropriate respiratory protection designed to filter out microscopic particles. Be sure to use adequate water pressure.

Over-exposure to vibration can lead to circulatory and/or nerve damage to the extremities, especially in cold temperatures (Reynaud's Disease).

If you experience tingling, numbness, pain or changes in skin color, particularly in your fingers, hands or wrists, stop using the saw immediately. If the problem persists, seek medical attention.

This machine produces an electromagnetic field during operation.

This field may under some circumstances interfere with active or passive medical implants. To reduce the risk of serious or fatal injury, we recommend persons with medical implants consult their physician and the medical implant manufacturer before operating this machine.

USING THE ICS SAW SAFELY



Following are the basic instructions to assure safe use of the saw. Also read and understand additional safety precautions specific to the operation and maintenance of the saw throughout this manual.

DANGER

DO NOT operate the ICS saw with a saw chain or saw bar designed to cut wood. Using wood cutting saw chain on the ICS saw could result in severe injuries to the operator or a bystander! Use **ONLY** the cutting attachments specified in this manual on this saw.

WARNING

DO NOT operate the saw with damaged, modified, broken, or missing components.

Below safety features are designed to protect against contact with moving parts, ejected debris, broken chain, thrown water, and concrete slurry.

- Side cover
- Mud flap
- Mud flap bracket (Chain Catcher)
- Rear hand guard
- Throttle trigger interlock

Use only Genuine ICS replacement parts. Use of unauthorized aftermarket parts may result in injury or damage to the saw.

DO NOT insert the guidebar into a slot narrower than the width of the chain.

Rapid pushback, kickback and/or chain breakage could result.

DO NOT operate the saw without an adequate water supply.

The integral water supply channels in the guidebar act to cool and lubricate the cutting system as well as to suppress dust and debris generated during cutting. Assure that the water supply is capable of delivering 1.5 bar (20 psi) pressure to the saw at a minimum flow rate of 4 lpm (1 gpm).

Never attempt to cut ductile iron pipe or similar pipe materials with the saw unless using PowerGrit® Utility Saw Chain.

Using concrete saw chain in these applications can cause the chain to snag abruptly in the cut which may result in chain breakage, pushback and/or kickback.

BOX CONTENTS

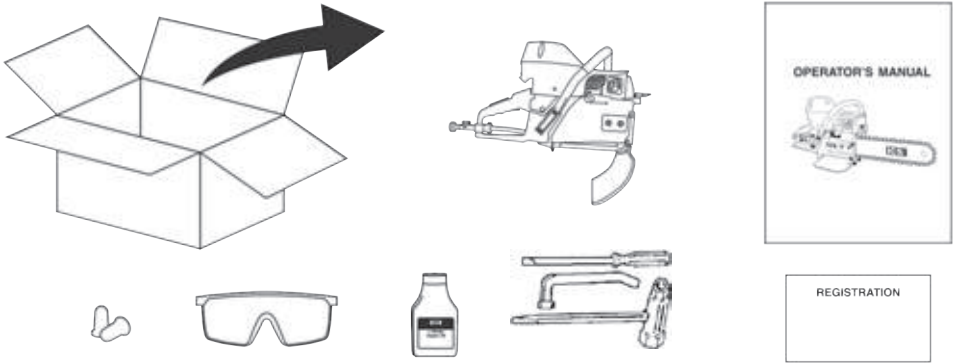

Minimum contents for all packages shown. Some packages also contain guidebar and diamond chain.

See page 44 for listing of compatible guidebars and diamond chain.

GUIDEBAR AND DIAMOND CHAIN INSTALLATION & TENSIONING



Following are the basic instructions for guidebar and diamond chain installation and tensioning.

WARNING

Never perform any maintenance or adjustments on the saw while the engine is running.

Be sure the multi-function lever is set to the "STOP" position before proceeding.

Improper chain tension can lead to failure of the chain or derailing of the chain off of the guidebar.

Check tension frequently and adjust if drive links of chain hang 18 mm (3/4 in) or more below the guidebar groove

CAUTION

Always wear gloves when handling the bar and chain.

These components can develop sharp edges and cause cuts.

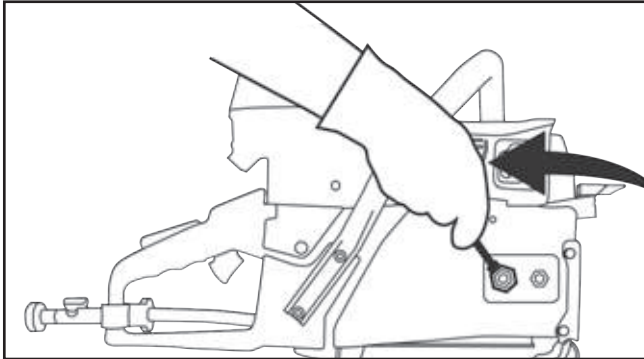
GUIDEBAR AND DIAMOND CHAIN INSTALLATION & TENSIONING**STEP 1**

Loosen side cover nuts and remove side cover.

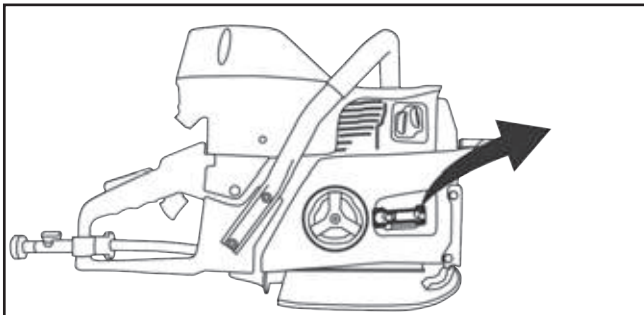
**STEP 2**

Remove shipping spacer.

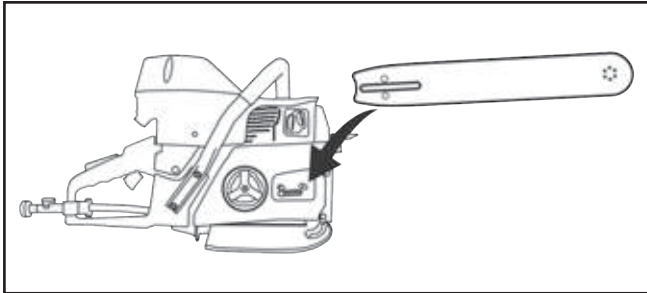
GUIDEBAR AND DIAMOND CHAIN INSTALLATION & TENSIONING**STEP 3**

Place guidebar onto studs and tensioning adjustment pin.

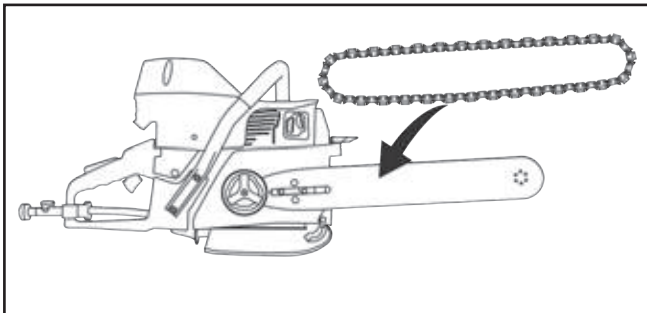
**STEP 4**

Mount the diamond chain on the guidebar starting at the drive sprocket and continue over the guidebar nose.

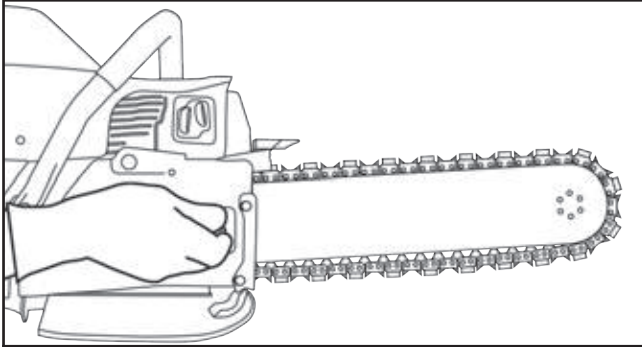
GUIDEBAR AND DIAMOND CHAIN INSTALLATION & TENSIONING**STEP 5**

Install the side cover and nuts. Do not fully tighten side cover nuts until chain is properly tensioned.

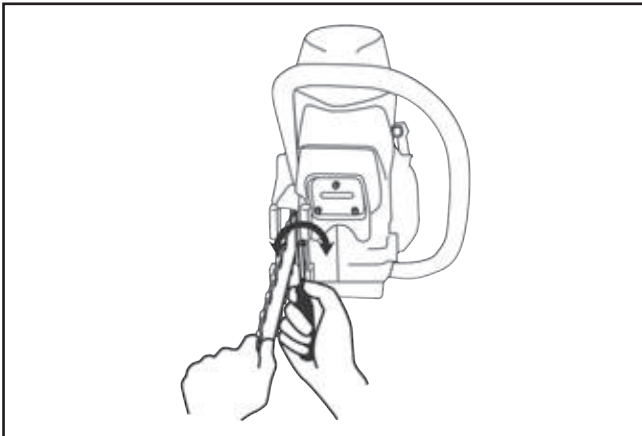
**STEP 6**

Make sure all the drive links are inside the guidebar groove then lift the bar nose and tension the chain by turning the tensioning screw clockwise.

GUIDEBAR AND DIAMOND CHAIN INSTALLATION & TENSIONING

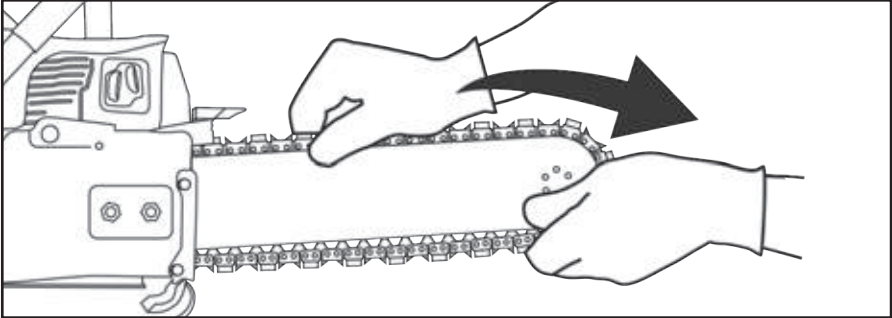

STEP 7

Check for proper tension by pulling the chain around the bar by hand. If you cannot easily pull by hand, the chain is too tight and needs to be loosened slightly.

CAUTION: Be aware that the guidebar rails may develop sharp edges over time so always pull the diamond chain by the diamond segments.

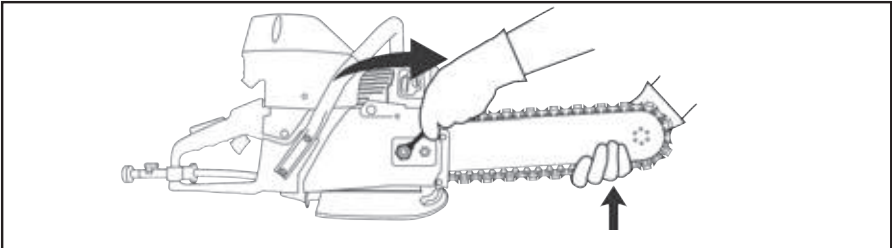

STEP 8

Continue to lift up on the nose of the guidebar and firmly tighten the side cover nuts.

NOTE: To prevent chain tensioner breakage, be sure the side cover nuts are tightened to approximately 27 Nm (20 ft-lbs).

CORRECT CHAIN TENSION

CHAIN TOO TIGHT

CHAIN TOO LOOSE

CHECKING & ADJUSTING CHAIN TENSION

All chains have a tendency to stretch when used. Diamond chains stretch more than wood cutting chains because of the abrasive materials they are cutting.

WARNING

Improper chain tension can lead to failure of the chain or derailing of the chain off of the guidebar.

Check chain tension frequently and adjust if drive links of chain hang 18 mm (3/4 in) or more below the guidebar.

CAUTION

Assure that proper chain tension is maintained.

If tension is set too tight, it will lead to excessive chain stretch, and most of the saw's power will be used just to overcome friction. In severe cases the chain may not turn at all, and can lead to chain breakage. If the tension is set too loose, the chain could be thrown off of the bar, or allow the sprocket to turn without turning the chain, which will damage the drive links.

IMPORTANT

When a chain stretches to a point where the drive links are hanging approximately 12 mm (1/2 in) to 18 mm (3/4 in) below the guidebar groove, it is time to tension the chain.

CONNECT TO WATER SUPPLY

Following are the basic instructions to assure correct water supply to the saw.

WARNING

ICS® diamond saws require a continuous water supply to the guidebar and chain. A key purpose of the supply water is dust suppression. The potential for airborne particulates depends on many factors including, but not limited to, the material being cut, application and cutting environment. In all cases, assure that the water supply is capable of delivering 1.5 bar (20 psi) pressure to the saw at a minimum flow rate of 4 lpm (1 gpm).

NOTE: Local and/or regional regulation can vary widely. It is the responsibility of the operator to wear appropriate dust protection applicable in their area and suitable to the application.

Never operate saw with insufficient water supply.

Insufficient water supply will result in excessive wear to the chain, which can lead to excessive stretch, chain breakage and/or damage to the guidebar nose sprocket.

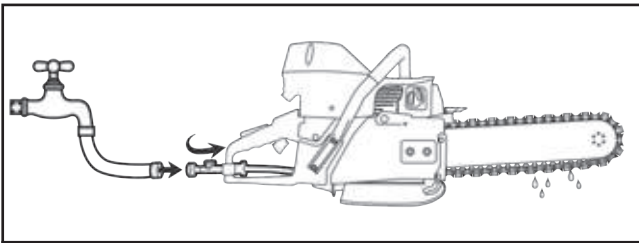

Attach to water supply capable of delivering 1.5 bar (20 psi) pressure to the saw at a minimum flow rate of 4 lpm (1 gpm). The single most important factor an operator can control to increase chain life is to use adequate water pressure.

FUELING

Following are the basic instructions to assure safe fueling procedures.

DANGER

Fuel vapors are highly flammable.

Turn off the saw, assure that the multi-function lever is set in the "STOP" position, and allow the engine to cool a few minutes before fueling. Do not smoke or refuel the saw in close proximity to any ignition sources. Move the saw at least 3 m (10 ft) from the fueling area before restarting it.

IMPORTANT

FUEL

ICS saws require the use of high quality, 90 Octane (95 RON) or higher fuel combined with ICS 2-stroke oil (or other high quality 2-stroke oil) specifically formulated for aircooled power equipment at a mixture of 4% (25:1). Due to the heavy duty cycle ICS saws are subjected to in concrete cutting applications, oil mixture and fuel quality are critical to the performance and life of the engine.

ALKYLATE FUELS

Alkylate fuel (i.e. Aspen 4) is an acceptable alternative to conventional fuel when combined with ICS 2-stroke oil (or other high quality 2-stroke oil) at a mixture of 4% (25:1).

NOTE: If using Aspen alkylate fuel or similar, carburetor adjustments are not necessary or recommended.

ETHANOL BLENDED FUEL

While ICS recommends using fuel that does not contain ethanol (alcohol), it is understood that 10% Ethanol blended fuel (E10) is becoming more widespread. ICS saws are not designed to operate with fuel containing more than 10% ethanol.

NOTE: The use of Ethanol blended fuel greater than E10 will cause improper operation and will cause major engine failure. This type of fuel related failure is not covered under warranty.

This saw is certified to be in conformance with Section 213 of the Clean Air Act by the US EPA.

Failure to follow instructions on preparing the fuel and oil mixture may result in emissions violations.

FUEL MIXING INSTRUCTIONS

CAUTION

Pressure can build up in the fuel tank and container and possibly cause sudden release of fuel vapors when the tank is opened.

Open the fuel cap slowly and always provide adequate ventilation when handling fuel.

IMPORTANT

It is important to accurately measure the amount of oil to be mixed with gasoline to assure that the correct mixture is obtained. When mixing small amounts of fuel, even small inaccuracies can drastically affect the ratio of the mixture.

Always mix gasoline and oil in a clean container approved for use with fuel. Keep fuel container closed tightly to prevent moisture from getting into the fuel. Do not mix more than one month's supply of fuel. This helps prevent the separation of the 2-stroke oil from the gasoline (varnishing).

Before fueling, clean the area around fuel cap on the saw to prevent dirt from contaminating the fuel. Contamination of the fuel tank can lead to saw malfunction.

Always begin mixing fuel by pouring half the amount of gasoline to be prepared into the mixing container. Then add the correct amount of 2-stroke oil for 4% (25:1) mixture and finish by adding gasoline to obtain the total quantity of mixed fuel. Shake the fuel container to thoroughly mix the gasoline and oil before adding to the saw. The table below shows the correct quantity of two-cycle oil to be used.

FUEL MIXTURE: 4% (25:1) mixture gasoline/oil.

| GASOLINE | OIL |
|-----------|----------|
| US Gallon | US Fl oz |
| 1 | 5.2 |
| 2 1/2 | 12.8 |
| 5 | 25.6 |

| GASOLINE | OIL |
|----------|-----|
| Liters | ml |
| 1 | 40 |
| 5 | 200 |
| 10 | 400 |
| 20 | 800 |

NOTE: If the saw is not used for an extended period of time (3 months) the fuel tank should be emptied and cleaned.

FUELING THE SAW**CAUTION****Do not overfill the fuel tank.**

Should any fuel spill happen, wipe up the spillage and allow the rest to evaporate. If fuel is spilled on yourself or your clothes, immediately remove contaminated clothing and wash any part of your body that has contacted fuel with soap and warm water.

Pressure can build up in the fuel tank and container and possibly cause sudden release of fuel vapors when the tank is opened.

Open the fuel cap slowly and always provide adequate ventilation when handling fuel.

After adding fuel, carefully install the fuel cap and tighten firmly by hand. Tip the saw slightly to one side and check for leaks. Should any fuel leaks be observed, do not start the saw.

Customers are encouraged to remain consistent in the fuel option they choose for ICS saws. Alternating between options, such as going between traditional fuel to Alkylate fuel (Aspen) and back again may have negative impacts on the engine.

OPERATION

Following are the basic instructions to assure safe operation of the saw.



Never start the saw without the bar, chain and side cover properly assembled.

DO NOT operate the saw with loose, missing, damaged or improperly installed or repaired parts.

Check that the components shown below are intact, undamaged, and installed correctly:

- Side cover nuts torqued down properly
- Side cover not damaged and discharge port not plugged
- Handles not loose, gripping area is clean and undamaged
- Mud flap is not ripped, torn or missing and fully attached to the saw
- Cylinder cover is properly secured in place
- Muffler not damaged and is adequately secured to cylinder
- Guidebar not bent or otherwise damaged such as rails dished and uneven
- Nose sprocket not excessively worn or broken, and turns freely
- Diamond chain does not have loose rivets, chassis damage, or missing diamond segments
- Chain tensioner mechanism functions properly and pin is not bent or broken
- Drive sprocket not excessively worn and slides easily on adapter
- Check alignment of drive sprocket and guidebar

PRE-OPERATION SAFETY CHECKS

Perform the following safety checks each day to be sure that the safety features designed into the saw are functioning properly. If any items are excessively worn or damaged, replace before use.

- With the multi-function lever set to the "STOP" position, without starting saw, pull starter rope slowly and inspect for fraying, wear and abrasion.
- Assure vibration isolators are intact.
- With engine running and without depressing throttle trigger lockout, pull throttle trigger and assure continuous chain movement does not occur.
- Verify at engine idle speed that the chain does not move.

STARTING & STOPPING THE SAW

WARNING

Be sure that no part of the cutting system is contacting a solid object when starting the saw.

When the multifunction lever is set to the choke and/or throttle advance position for starting, the chain may move and cause the saw to react if the chain contacts a solid object.

CAUTION

Move the saw at least 3 m (10 ft) from the fueling area before starting it.

Assure that secure footing is established and chain is not contacting any objects.

When starting the saw, place the saw on clear and level ground.

IMPORTANT

Failure to break-in an engine may result in piston seizure.

It is very important to break-in a new engine to “seat” all moving parts, especially the piston rings. To break-in the engine, run one full tank of 4% (25:1) fuel at idle, cycling the throttle every 5 to 10 minutes to prevent loading.

Do not obstruct air intake.

Loose clothing can inadvertently be drawn into air intake and obstruct air flow which may result in engine stall.

STOPPING THE SAW

To turn the engine off, push the multi-function lever down until engine stops. The multi-function lever will then remain in the “STOP” position and prevent starting. Close water valve completely.

COLD ENGINE STARTING PROCEDURE

1. Move the multi-function lever to the upper-most position which also sets the choke and throttle advance.
2. Open the water valve 1/4 turn.
3. Place foot on base of rear handle, and place one hand of front handle.
4. With opposite hand, slowly pull starter handle until you feel the starter pawls engage.
5. Pull the starter cord (hard, fast, short pulls) **until engine initially fires or "pops"**. Do not exceed 5 pulls in this step.
6. Move the multi-function lever to the middle position, which releases the choke but keeps the throttle in the advance position.
7. Pull the starter cord until the engine starts – should be 1 to 2 pulls.
8. Release the throttle advance by pulling and releasing the throttle trigger, which allows engine to return to normal idle speed.
9. Allow the engine to idle briefly, then pull throttle trigger several times to help warm up the engine.
10. Open the water valve completely.

WARM ENGINE STARTING PROCEDURE

1. Move the multi-function lever to the middle position. If the multi-function lever is in the upper-most position on a warm engine, the carburetor will flood with gas. If this occurs, see troubleshooting section .
2. Open the water valve 1/4 turn.
3. Place foot on base of rear handle, and place one hand of front handle.
4. With opposite hand, slowly pull starter handle until you feel the starter pawls engage.
5. Pull the starter cord (hard, fast, short pulls) until engine starts .
6. Allow the engine to idle briefly, then pull throttle trigger several times to help warm up the engine.
7. Open the water valve completely.

PRECUT CHECKLIST

**WARNING**

Sudden contact of the guidebar nose with a foreign object may generate kickback.

Remove and/or avoid any obstructions (plumbing, water supply hoses, electrical conduit, air ducts, etc.) that may interfere with the cut.

To avoid electrocution, check for live electrical wires.

Wires may be hidden within or behind walls and/or laying around the workspace. Assure that any ancillary electrical equipment (fans, pumps, vacuums, etc.) are properly grounded and certified for use in the intended environment.

Always operate the saw with solid footing and both hands on the saw.

Keep your left hand on the front handle and your right hand on the rear handle. Wrap your thumbs around the handles to assure you maintain a secure grip on both handles.

Never operate the saw during severe inclement weather.

Freezing conditions, lightning, sudden downpours can create hazardous jobsite conditions.

Always wear protective clothing.

At a minimum always wear eye protection and/or face shield, hearing protection, long sleeve shirt, long pants, closed toe shoes with non-slip soles, and gloves. In many work situations, a hard hat, steel toed shoes and a respirator may also be required. Avoid loose fitting clothing.

Cutting with the saw may generate sparks, especially when cutting through metal (such as rebar), and may start a fire in combustible materials such as dry grass, wood and fuel.

Be sure to use adequate water pressure and have fire fighting equipment readily available.

CUTTING WITH THE SAW**⚠ WARNING**

DO NOT insert the guidebar into a slot narrower than the width of the chain. Rapid pushback, kickback and/or chain breakage could result.

Be sure cut concrete cannot fall and injure the operator or bystanders.

Assure cut piece is controlled and does not fall unexpectedly.

NOTE: Concrete is very heavy; one cubic foot = 30 cm x 30 cm x 30 cm = 68 kg (12 in x 12 in x 12 in = 150 lbs).

⚠ CAUTION

Slippery or unstable surfaces such as ladders may cause a loss of balance or control of the saw.

Always keep proper footing and operate the saw only when standing on fixed, secure and level surface.

Unexpected loss of control of the saw and loss of balance can result in injury.

Do not overreach and do not cut above shoulder height.

Do not allow workpiece to pinch the guidebar and chain, or rapid pushback could result.

Always cut bottom of opening first and assure workpiece is secure and does not shift during cutting operations.

Do not operate saw upside down.

Cutting debris can be directed back towards the operator.

Take special precautions when cutting in horizontal orientation.

Be aware that debris may be ejected differently than when cutting in a vertical position.

IMPORTANT

Always operate saw at full throttle.

For best results, always operate the saw at full power.

CUTTING WITH THE SAW

To assure the best performance from your ICS saw, follow all safety precautions and recommended techniques. Additional helpful information can be obtained at icsdiamondtools.com.

CONCRETE/MASONRY CUTTING**Planning the Cut**

1. Select the proper chain type for the material being cut. Refer to the chain selection guide in this manual. See page 44.
2. Outline the cut with a permanent marker for a visual cutting guide.
3. Avoid pinching the guidebar and chain by using shims or other anchoring devices to stabilize the workpiece. Always plan to cut the bottom of an opening first, then top or sides. Save the easiest cut for last. (see image at right)
4. Be sure cut concrete cannot fall and injure the operator or bystanders. As the cut is being completed, assure that appropriate bracing is in place to control the cut section of the workpiece. Concrete is very heavy, one cubic foot = 30 cm x 30 cm x 30 cm = 68 kg (12 in x 12 in x 12 in = 150 lbs)

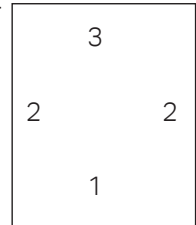

CONCRETE/MASONRY CUTTING

Recommended Concrete Cutting Techniques

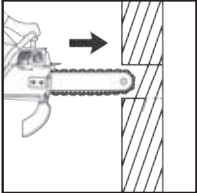
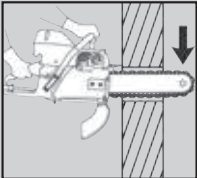
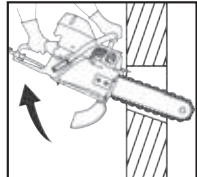
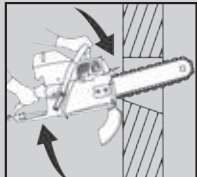
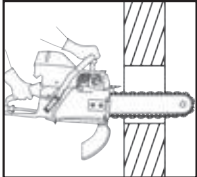
| | |
|---|--|
| <p>1. Plunge in</p> |  |
| <p>2. Cut down to open slot</p> |  |
| <p>3. Insert WallWalker® rotate rear handle up</p> |  |
| <p>4. Pull saw out, rotate rear handle down, press bottom of saw to leading edge of cut and rotate rear handle up</p> |  |
| <p>5. Reengage WallWalker® and repeat Steps 3 and 4</p> |  |

CUTTING TIPS

- For the straightest cuts use the “Step Cut” method:
 - First score the entire cut line approximately a half-inch deep using the nose of the guidebar.
 - Next, deepen the cut by about two inches
 - Then plunge all the way through and complete the cut using the WallWalker® as a pivot point and pull on the rear handle to rotate the bar into the cut.
- Always operate the concrete saw at full throttle. If too much force is applied, the saw will lug or stall. The chain will not have enough speed to cut effectively. If too little feed force is applied, the diamonds will skid and glaze over.
- Plunge cut instead of starting at the top surface of the wall. This will reduce chatter, extend diamond life, create a straighter cut and more quickly enable the use of the WallWalker.
- When cutting heavy rebar, slowly “rock” the saw so that you’re always cutting concrete as well as steel. This will help keep the diamonds exposed. Also, expect less chain life when cutting heavy rebar.
- Expect more chain stretch when making nose-buried cuts for extended periods of time, as the chain does not have a chance to “throw” the slurry away from the nose of the guidebar.
- If the saw begins to cut consistently crooked, stop the saw, remove the bar and chain and turn the bar over and use the other side. Dress worn rails with a belt sander.
Note: The normal life of a guidebar is two to three diamond chains. Heavy rebar can shorten guidebar life.
- The guidebar is solely a guide track for the chain. Never use the guidebar to lift, twist or pry concrete material
- When using a new chain, you can increase the initial cutting speed by “opening up the diamonds”. This can be accomplished by first making a few cuts in an abrasive material such as a cinder block or brick.

This page intentionally left blank

TRANSPORTING & STORING**WARNING****Fuel and vapors are highly flammable**

When transporting or storing fuel, always use a container approved for fuel and assure it is sealed against leaks and/or escaping fumes. Contact with an ignition source could cause fire or explosion.

CAUTION**Always carry the saw by the front handle with the multi-function lever set to the "STOP" position and away from your body**

When transporting the saw, assure it is secured to avoid damage and/or personal injury. Proper handling of the saw will reduce the likelihood of accidental contact with the guidebar and chain.

IMPORTANT

ICS recommends mixing fuel in small batches, to be used within 30 days. Fuel stabilizers (additives) can prolong the life of the fuel, but still should not be stored longer than 90 days.

MAINTENANCE AFTER EACH USE

IMPORTANT

1. After cutting, pull trigger to spin the chain for at least 15 seconds with the water on to flush slurry and debris from chain, guidebar and drive sprocket.
2. Stop saw and wash concrete slurry from saw assembly with special attention to the starter housing and flywheel. Do not let slurry dry on saw as it will be very difficult to remove later.
3. Avoid getting any water in the carburetor or exhaust system. If water enters the exhaust port, it can enter the carburetor. To make sure there is no water in the exhaust system, assure the multi-function lever is set to "STOP" position, point the guidebar tip down and pull the starter handle several times to expel water from muffler.
4. Remove the chain and guidebar. Flush out the chain tensioner and side cover with water. Lubricate tensioner with waterproof grease.
5. After cleaning the saw, spray the entire saw body, chain, guidebar, and drive sprocket with lightweight oil. Using lightweight oil on the saw will minimize rust and help reduce slurry build up.
6. Inspect and tighten all fasteners as necessary.
7. Inspect drive sprocket for wear. Replace if tooth tips are pointed, or if groove cuts through top of tooth.
8. Check clutch cup needle bearing for wear. Assure clutch cup spins freely and without excessive play.
9. Check starter cord for wear or damage. Replace as necessary.
10. Inspect air filter. Replace filter if dirty or wet.
11. Spray lightweight oil into the air intake slots on the starter housing and flywheel (this will prevent the starter pawls from sticking).

AFTER EVERY 10 HOURS OF USE

1. Remove the starter cover and clean the flywheel fins and the starter pawls with a wire brush, then apply waterproof grease to the starter pawls.
2. Remove the spark plug and clean with a wire brush. Check the electrode gap. The correct gap is 0.5 mm (0.020 in). Replace if necessary.

AFTER EVERY 40 HOURS OF USE

1. Change the spark plug. Adjust the electrode to 0.5 mm (0.020 in).
2. Check the fuel filter located inside the fuel tank. Clean or replace if clogged.

| After each use | After every 10 hours | After every 40 hours |
|--------------------------|-----------------------|-----------------------|
| External Cleaning | Clean Starter Housing | Replace Spark Plug |
| Fasteners/Screws | Check Spark Plug | Check Fuel Filter |
| Air Intake | | |
| | | |
| Functional Inspection | Functional Inspection | Functional Inspection |
| General Inspection | Vibration Isolators | Fuel System |
| Throttle Trigger Lockout | Muffler | Fuel Filter |
| Multi-function Lever | Carburetor | Air Filter |
| Mud Flap | Starter Housing | Clutch Cup |
| Guidebar and Chain | Sprocket | Clutch |

AIR FILTER

The polyester air filter must be kept clean for the engine to operate properly. If the saw is not reaching full RPM, most likely the air filter is dirty or wet.

- The air filter should be free of holes and white in color
- Replace the air filter when dirty or wet.
- When replacing the air filter, clean the area inside the air box with a clean towel prior to installing new filter
- Inspect air box seal for wear or damage. Replace if damaged.

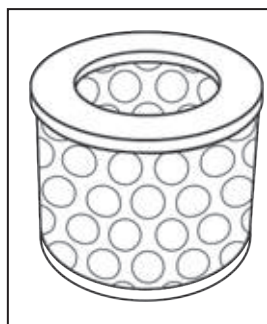

FUEL SYSTEM

- Clean area around fuel cap before removing.
- Check the fuel cap and seal for damage.
- Check the fuel line for damage.
- Check fuel filter, assure it is free of debris.
- Replace fuel filter if it is stained dark or clogged (fuel filter cannot be cleaned).

SPARK PLUG

- Clean the spark plug with a wire brush and check to assure the plug gap is 0.5 mm (0.020 in).
- Inspect the spark plug boot, replace if needed.
- Inspect lead wire for wear or damage. Replace if necessary (lead wire cannot be replaced separately from ignition module).

IMPORTANT

- Replace spark plug after 40 hours of use, or if the electrode is corroded or eroded.
- Always use a recommended spark plug (resistor type) to prevent damage to the piston and cylinder. (NGK #BPMR8A or Champion RCJ7Y or equivalent).

CARBURETOR

- The function of the carburetor is to mix fuel with air. Adjustments other than idle speed should only be made by an authorized service center.
- Before adjusting the engine idle speed, make sure the air filter is clean, the engine is running, warmed up and the guidebar and chain are assembled on the saw.
- Adjust idle screw so that the engine idles smoothly but the clutch does not engage. If the chain begins to spin, turn the idle screw counter-clockwise until the chain stops.
- If saw has been running satisfactorily and there is a gradual decrease in power and drop in RPM at full throttle, the filter may have become dirty or wet. (See air filter section).

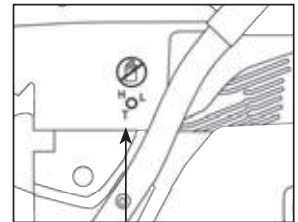

Carburetor idle screw

STARTER RECOIL HOUSING

It is common for concrete slurry to get inside the starter housing assembly during cutting. This can cause starter pawls to stick and not engage when the rope is pulled.

- After each usage, thoroughly flush the starter housing assembly with water.
- Spray lightweight oil into the air intake slots on the starter housing and flywheel (this will prevent the starter pawls from sticking).
- Inspect the starter cord for fraying, replace if necessary.

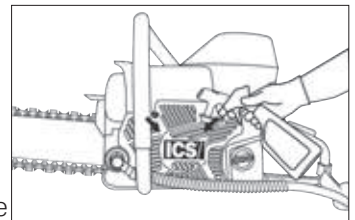

STARTER ROPE REPLACEMENT

- Loosen the four screws that attach the starter cover assembly to the crankcase, and remove the starter cover assembly from the saw.
- Remove starter cord shield screws.
- Pull 10 - 15 cm (4-6 in) of rope out.
- Line rope up with notch on pulley.
- Using your thumb on the pulley as a brake, slowly rotate pulley counter-clockwise until spring pressure is released.
- Remove starter pulley screw and washer.
NOTE: Hold starter cover firmly.
- Remove starter pulley.
- Clean and inspect the pulley spring catch, replace if worn or broken.
- Install starter rope and tie knot at pulley end.
- Wind rope onto pulley clockwise, leaving 10 - 15 cm (4 - 6 in) from the handle end, and install pulley.
NOTE: Assure that the pulley spring catch is in the spring hook.
- Install center screw, spacer and washer.
 Use Loctite® 242.
 Torque to 2.9 Nm (26 in-lbs).
- Assemble starter cord shield.

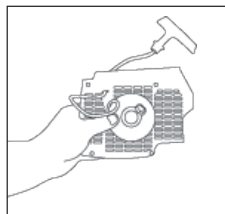

TENSIONING THE RECOIL SPRING

- Hook the rope in the notch of pulley and wind the rope clockwise three times around the raised center of the pulley.
- Pull the starter rope with the handle until the rope is unwound, tensioning the spring. Repeat this process, but this time, wind the rope clockwise four times around and then pull the rope with the handle to complete the tensioning of the spring.

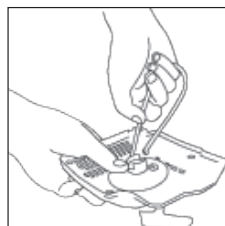

NOTE: When released, the starter handle should be drawn to the correct start position after tensioning the spring.

IMPORTANT

Check that the pulley can be turned an additional 1/2 turn when the starter cord is pulled all the way out.

STARTER RECOIL HOUSING ASSEMBLY

- To reattach the starter cover assembly, first pull the starter cord out, then hold the starter recoil housing against the crankcase
- Slowly release the starter cord to enable the pulley to fit between the pawls.
- Insert and tighten the screws. Use blue Loctite® #242.

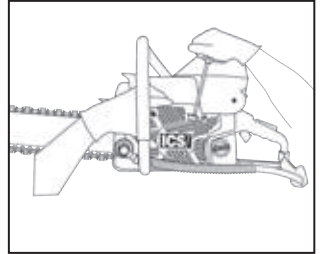

CHAIN TENSIONER

The chain tensioner can become clogged with concrete slurry during cutting.

- After each use thoroughly flush the chain tensioner with water and apply a liberal amount of waterproof grease covering the chain tensioner screw.

Chain Tensioner

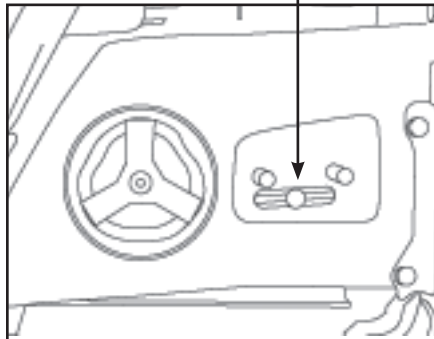

DRIVE SPROCKET

- The drive sprocket (rim sprocket) is a wear item and should be replaced every two to three chains, or when the teeth become pointed or if groove cuts through top of tooth.
- Inspect the sprocket for wear.
- The needle bearing inside the splined adapter should be greased regularly and should be replaced with each new clutch cup. A rim sprocket system consists of a clutch cup w/ splined adapter and a rim sprocket. When the rim sprocket wears out, it is the only part that needs to be replaced. The clutch cup with splined adapter is a wear item that needs replacement after 3 to 5 rim sprockets have been used.
- Check the drive sprocket bearing by spinning clutch cup. Replace the bearing if it is worn out.

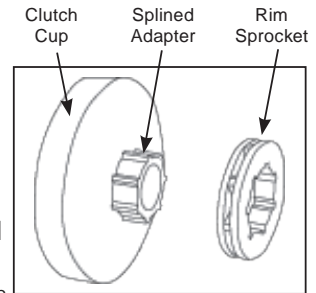

DRIVE SPROCKET ASSEMBLY REMOVAL/INSTALLATION

- Remove the side cover, guidebar, diamond chain, and clutch slurry shield.
- Remove the spark plug and insert the piston stop (supplied with each saw) into the spark plug hole. Pull the starter cord slowly until the piston stops. Use a 19 mm wrench to turn the clutch **clockwise** and remove.
- Slide the clutch cup/drive sprocket assembly off the shaft. Remove the needle bearing and inspect for heavy wear or damage.
- Slide the rim sprocket onto the splined adapter, either side out.
- Apply a liberal amount of grease to the needle bearing.
- Place the thin metal washer onto drive shaft. Slide the needle bearing and clutch cup w/rim sprocket onto shaft.
- Install the clutch by turning it **counter clockwise** on the drive shaft and firmly tighten. Replace the clutch slurry shield. Installation of drive sprocket assembly is now complete.

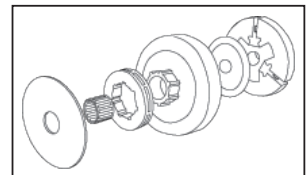
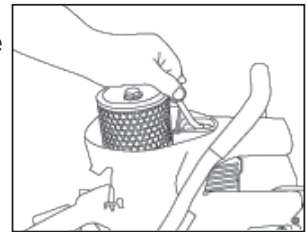

CHAINS & GUIDE BARS



IMPORTANT

Inspect chain segments and drive links for damage or excessive wear. Chains with damage or excessive wear should not be used or repaired, they should be replaced.

NOTE: Guidebars are designed to be used on both sides. If the cut is consistently leading to one side, turn the guidebar over. It is recommended to turn the guidebar over with every new chain.

- A table mounted belt or disc sander can be used to square the rails of a worn guidebar. A badly worn guidebar can quickly damage the chain. If the chain is touching the bottom of the guidebar groove, replace the guidebar.
- Check the guidebar for straightness.
- Proper chain tension will extend guidebar life.
- Under some circumstances, especially low water pressure, the sprocket nose can wear out before the guidebar body. Sprocket nose assemblies may be replaced by an Authorized Service Center.
- Periodically clean the water ports inside the groove of the guidebar using a small diameter piece of wire or pipe cleaner.
- The guidebar is solely a guide track for the chain. Never use the guidebar to lift, twist or pry concrete material.
- Prior to storage, spray the chain and guidebar with lightweight oil.

680ES CHAIN SELECTION GUIDE & CONSUMABLES

| 3/8" Pitch Chain Selection Guide | | | | | |
|---|-------------------------------|---------------|---|--|------------------------------------|
| Chain & Applications | Soft Stone/ Abrasive/Brick | Natural Stone | Medium Concrete/Light Reinforcement | Hard Concrete/ Heavy Reinforcement | Ductile Iron/Cast Iron/PVC/HDPE |
| TwinMAX™ <i>General Purpose</i> | | ♦ | ♦ | | |
| TwinMAX™ Plus <i>For harder materials</i> | | ♦ | ♦ | ♦ | |
| TwinMAX™ Abrasive <i>For brick & block</i> | ♦ | | | | |
| 3/8" Pitch Consumables | | | | | |
| | | 30 cm (12 in) | | 35 cm (14 in) | |
| TwinMAX™ Diamond Chain | | p/n 71400 | | p/n 71486 | |
| TwinMAX™ Plus Diamond Chain | | p/n 71704 | | p/n 71705 | |
| TwinMAX™ Abrasive Diamond Chain | | p/n 71554 | | p/n 71610 | |
| 3/8" Pitch Guidebar | | p/n 71395 | | p/n 513122 | |
| 3/8" Pitch Drive Sprocket | | p/n 70949 | | | |

TROUBLESHOOTING

| PROBLEM | Possible Cause |
|--------------------------|--|
| SAW WON'T REACH FULL RPM | Dirty air filter. |
| SLOW CHAIN SPEED | Chain tension too tight. Chain should always be able to be pulled around the guidebar by hand. It is normal for the drive links of the chain to hang below the guidebar. |
| POOR CUTTING SPEED | All of the above, plus diamonds may be glazed over. Make a few cuts in an abrasive material to expose the diamonds. |
| PREMATURE CHAIN STRETCH | Not enough water pressure. The minimum water pressure required is 1.5 bar (20 psi). Insufficient water supply may result in excessive wear to the chain, which can lead to stretch and chain breakage. |
| CHAIN TENSIONER BREAKAGE | Side cover nuts are not tight enough. Torque to 27 Nm (20 ft-lbs). |
| | Tensioning with side cover nuts already tight. |
| WATER NOT FLOWING | Water hose is kinked or water supply not turned on. |
| | Water ports plugged with debris. |
| WON'T START | Aged or bad fuel. |
| | Corroded or eroded spark plug. |
| | Multi-function lever in "STOP" position. |
| DIFFICULT TO START | Flooded engine. Put Multi-function lever in the middle position hold throttle on full with foot and pull starter cord (hard, short, fast pulls) until engine starts. |
| | Fouled spark plug. Remove spark plug, clean, and re-gap to 0.5 mm (0.020 in). |
| CHAIN BREAKAGE | Improper chain tension. |
| | Insufficient water pressure. |
| | Inserting saw into slot narrower than diamond chain segments. |
| | Using chain that is already stretched beyond ability to tension |

This page intentionally left blank

FEDERAL EMISSION CONTROL WARRANTY STATEMENT

YOUR WARRANTY RIGHTS AND OBLIGATIONS

The U.S. Environmental Protection Agency (EPA), Environment Canada and ICS, Blount Inc. are pleased to explain the Emissions Control System Warranty on your 2009 and later small non-road engine. In the U.S. and Canada, new small non-road engines must be designed, built and equipped to meet federal emission regulations.

ICS® must warrant the emission control system on your small non-road engine for the period of time listed below provided there has been no abuse, neglect or improper maintenance of your unit.

Your emission control system includes parts such as the carburetor and the ignition system. Also included may be hoses, connectors and other emission related assemblies.

Where a warrantable condition exists, ICS will repair your saw engine at no cost to you. Expenses covered under warranty include diagnosis, parts and labor.

MANUFACTURER'S WARRANTY COVERAGE

The emission control system on 2009 and later small non-road engines is warranted for two years. If any emission related part on your engine (as listed above) is defective, the part will be repaired or replaced by ICS.

FEDERAL EMISSION CONTROL WARRANTY STATEMENT

OWNER'S WARRANTY RESPONSIBILITIES

As the saw owner, you are responsible for the performance of the required maintenance listed in your Operator's Manual. ICS® recommends that you retain all receipts covering maintenance on your saw engine, but ICS cannot deny warranty solely for the lack of receipts or for your failure to assure the performance of all scheduled maintenance. However, ICS reserves the right to deny warranty coverage if your saw engine, or a part of it, has failed due to abuse, neglect, improper maintenance, unapproved modifications or the use of parts not made or approved by the original equipment manufacturer.

You are responsible for presenting your saw engine to an ICS authorized servicing dealer as soon as a problem exists. The warranty repairs should be completed in a reasonable amount of time, typically not to exceed 30 days.

If you have any questions regarding your warranty rights and responsibilities, please contact an ICS customer service representative at 1.800.321.1240. www.icsdiamondtools.com

LENGTH OF COVERAGE

ICS warrants to the initial purchaser and each subsequent owner that the engine is free from defects in materials and workmanship which cause the saw engine to fail to conform with applicable emission regulations for a period of two years.

WARRANTY PERIOD

The warranty period begins on the date of sale of the saw engine to the initial purchaser.

TECHNICAL SPECIFICATIONS

| | |
|---|---|
| Engine Type | 2-stroke, Air Cooled |
| Displacement | 76.5 cc (4.7 cu-in) |
| Horsepower | 3.7 kW (5 hp) @ 9,500 rpm |
| Torque | 4.1 Nm (36.3 in-lbs) @ 6,500 rpm |
| Engine Speed | 11500 +/- 500 rpm (max) 2,800 - 3,200 rpm (idle) |
| Chain Speed at Maximum Power | 34.5 m/s (6800 ft/min) |
| Weight | 9.5 kg (21 lbs) powerhead only |
| Powerhead Dimensions | 46 cm (18 in) length 29 cm (11.5 in) height 25 cm (10 in) width |
| Air Filter | Water resistant polyester |
| Carburetor | Walbro WJ-136 |
| Starter | Dust and water resistant |
| Ignition | Special water resistant electronic ignition |
| Clutch | Centrifugal, three shoe, single spring |
| Fuel ratio | 4% (25:1) gasoline-to-oil |
| Fuel Capacity | 0.88 liter (0.23 gallon) |
| Water Supply Requirement | Minimum 1.5 bar (20 psi) |
| Water Flow Requirement | Minimum: 4 lpm (1 gpm) |
| Guaranteed Sound Power Level, L_{wa} (1) | 117 dB(A) ($K_{wa} = 3.0$ dB(A)) |
| Equivalent Sound Pressure at the Operator's Ear, L_{pA} (1) | 101.0 dB(A) ($K = 2.0$ dB(A)) |
| Vibration, $a_{hw,eq}$ Concrete Cutting (2) | 7.2 m/s ² ($K=1.0$ m/s ²) Front Handle 8.5 m/s ² ($K=1.0$ m/s ²) Rear Handle |
| Engine Break-in Period | One tank, without cutting, cycling throttle |
| Spark Plug | NGK BPMR8Y or Champion RCJ7Y Electrode gap 0.5 mm (0.020 in) |

(1) Measured in accordance with ANSI S12.51-2012/ISO3741:2010

(2) Measured in accordance with ISO5349-1:2001 and ISO22867:2011

AUTHORIZED SERVICE CENTERS

| DEALER | PHONE | ADDRESS | CITY | STATE | POSTAL CODE |
|--------------------------------|--------------|---------------------------------|---------------|-------|-------------|
| KENNEDY EQUIPMENT CO INC | 714.771.7324 | 748 N. LEMON ST. | ORANGE | CA | 92867 |
| ABLE TOOL EQUIPMENT | 860.289.2020 | 410 BURNHAM STREET | SOUTH WINDSOR | CT | 06074 |
| EQUIPSERV LLC | 770.709.5101 | 6225 MABELTON PARKWAY SW | MABLETON | GA | 30126 |
| STAR EQUIPMENT | 515.283.2215 | 1401 2nd AVE | DES MOINES | IA | 50314 |
| MCCANN INDUSTRIES, INC. | 630.627.8700 | 543 SOUTH ROHLWING RD | ADDISON | IL | 60101 |
| CLEAN RITE TECH | 504.468.7997 | 1332 FULTON ST | KENNER | LA | 70062 |
| ACE CUTTING EQUIPMENT | 248.449.4944 | 25806 NOVI RD. | NOVI | MI | 48375 |
| CONCRETE CUTTING & CORING | 952.882.0980 | 12690 CREEK VIEW AVE. | SAVAGE | MN | 55378 |
| ACME ELECTRIC | 218.628.3523 | 4332 GRAND AVE | DULUTH | MN | 55807 |
| MERLIN STELZER SALES CO., INC. | 314.535.7540 | 4109 PAPIN ST. | ST. LOUIS | MO | 63110 |
| ACME ELECTRIC | 701.258.1267 | 3840 E. ROSSER AVE | BISMARCK | ND | 58501 |
| ACME ELECTRIC | 701.746.6481 | 1705 12TH AVE NORTH | GRAND FORKS | ND | 58203 |
| ACME ELECTRIC | 701.476.4600 | 920 36TH STREET S.W. | FARGO | ND | 58103 |
| ACME ELECTRIC | 701.839.2263 | 700 20TH AVE S.E. | MINOT | ND | 58701 |
| ADMAR SUPPLY | 585.272.9390 | 1950 BRIGHTON-HENRIETTA TL RD | ROCHESTER | NY | 14623 |
| ADMAR SUPPLY | 315.433.5000 | 6014 DROTT DR | EAST SYRACUSE | NY | 13057 |
| ADMAR SUPPLY | 518.690.0750 | 878 ALBANY SHAKER RD | LATHAM | NY | 12110 |
| ADMAR SUPPLY | 607.754.4700 | 2305 OLD VESTAL RD | VESTAL | NY | 13850 |
| ADMAR SUPPLY | 716.873.8000 | 1394 MILITARY RD | BUFFALO | NY | 14217 |
| CESSCO, INC. | 503.288.1242 | 4222 N.E. COLUMBIA BLVD. | PORTLAND | OR | 97218 |
| TRI-BORO CONST. SUPPLIES | 800.632.9018 | 435 LOCUST ST | DALLASTOWN | PA | 17313 |
| LEHIGH CONSTRUCTION SUPPLY CO. | 570.654.3981 | 295 SCHOOLEY AVE | EXETER | PA | 18643 |
| DRIVEKORE, INC. | 717.766.7636 | 101 WESLEY DRIVE | MECHANICSBURG | PA | 17055 |
| ECKHART CONSTRUCTION | 803.802.6635 | 1019 SOCIETY LANE | FORT MILL | SC | 29707 |
| STAN HOUSTON EQUIPMENT | 605.336.3727 | 501 SOUTH MARION ROAD | SIOUX FALLS | SD | 57106 |
| STAN HOUSTON EQUIPMENT | 605.348.1155 | 1210 DEADWOOD AVENUE | RAPID CITY | SD | 57702 |
| LINCOLN CONTRACTORS SUPPLY | 414.541.1327 | 11111 WEST HAYES AVE | MILWAUKEE | WI | 53227 |
| LINCOLN CONTRACTORS SUPPLY | 608.249.6476 | 901 WALSH RD | MADISON | WI | 53714 |
| LINCOLN CONTRACTORS SUPPLY | 715.359.6111 | 5207 WESTFAIR AVE | SCHOFIELD | WI | 54476 |
| LINCOLN CONTRACTORS SUPPLY | 920.757.1901 | 5663 NUEBERT RD | APPLETON | WI | 54913 |
| LINCOLN CONTRACTORS SUPPLY | 920.432.8697 | 1654 MORROW ST | GREEN BAY | WI | 54302 |
| LINCOLN CONTRACTORS SUPPLY | 715.874.4100 | 7840 PARTRIDGE AVE | EAU CLAIRE | WI | 54703 |
| LEE JENSEN SALES CO, INC | 815.459-0929 | 101 WEST TERRA COTTA | CRYSTAL LAKE | IL | 60014 |
| ROCK-CRETE EQUIPMENT LTD. | 604.464-1448 | 50 BURBIDGE STREET | COQUITLAM | BC | V3K 6B1 |
| CONCUT DIAMOND PRODUCTS | 561-989-8895 | 6500 W ROGERS CIRCLE SUITE 6000 | BOCA RATON | FL | 33487 |
| AUSTECH SUPPLIES PTY LTD | 61298541200 | UNIT 12, 197 POWER STREET | GLENDENNING | NSW | 2761 |
| HATCH BUILDING SUPPLY COMPANY | 608.222-0011 | 5601 MANUFACTURERS DRIVE | MADISON | WI | 53704 |
| AMERICAN TOOL AND FASTENER | 972-801-9909 | 1331 E PLANO PKWY STE #B | PLANO | TX | 75074 |
| HENARD UTILITY PRODUCTS, INC | 501.268-1987 | 1920 S. MAIN STREET | SEARCY | AR | 72143 |

DECLARATION OF CONFORMITY



EC- DECLARATION OF CONFORMITY

According to Directive 2006/42/EC; Annex 2A

Blount International Inc.4909 SE International Way
Portland Oregon, 97222 USA**DECLARES THAT THE FOLLOWING PRODUCT(S):****Equipment Name:** Cut-off machine equipped with diamond saw chain**Brand Name:** ICS**Model Number:** 680ES**Serial number(s):** From manufacturing year 2015's serial numbers and beyond**MEETS OR EXCEEDS THE REQUIREMENTS IN THE FOLLOWING EUROPEAN DIRECTIVE(S) AND/OR STANDARD(S):**

Machinery Directive 2006/42/EC

Electromagnetic Compatibility (EMC) 2004/108/EC

Registration, Evaluation, Authorization and Restriction of Chemicals (REACH) 1907/2006

Restriction of Hazardous Substances (RoHS) 2002/95/EC

Noise Directive (ODN) 2000/14/EC according to ANNEX V, see technical specifications

EN ISO14982:2009; CISPR12:2007+AMD1:2009

CLARIFICATION OF PRODUCT CLASS: The ICS 680GC Gas Saw, using the appropriate genuine ICS Diamond Chain, is designed to ONLY cut concrete or designated materials other than wood. The cutting means is by grinding through the work piece, using a continuous water supply as a coolant and lubricant. **This product is not intended for use with conventional wood cutting saw chain.**

Corporate Representative:

John DeHaven
Product Safety & Compliance Manager
Blount International Inc. Portland Or. 97222 USA**Manufacturer's Representative in the EC and authorized to compile the technical file**Marnix Kuypers
Blount International-Europe-S.A.
Rue Emile Francqui, 5
1435 Mont-Saint-Guilbert
Belgium**Date / Place:**

23JUN2015, Portland OR.

ICS | BLOUNT, INC.
4909 SE International Way
Portland, OR 97222 USA
800.321.1240
icsdiamondtools.com