

## BZL Pro-Grip Max® Features and Benefits

### Swan Necks

- High temperature resistant insulation materials reducing the risk of shorting
- Durable and Robust

### Contact Tips

- Manufactured using a harder and higher conductivity copper alloy than the OEM

### Nozzles

#### Maximises Performance

- Maximum wall thickness gives longevity and superior performance
- Manufactured to the same specifications as the OEM

### Pro-Grip Max® Handle System Ergonomically Superior

- Integrated soft grips ensure the handle remains in place with minimal grip pressure
- Enhances wire feeding performance
- Screwless design for rapid servicing

### Cable Supports Improved Wire Feed

- The perfect balance of freedom of movement and progressive support to the power cable is achieved

### Hanger Hooks Easy to store

- Less prone to damage
- Encourages an efficient and tidy workspace

### Knuckle Joint

#### Improved Manoeuvrability

- Small movements of the handle and neck are possible independently of the cable assembly

### Hydroflex™ Cable Systems

- Liquid cooled cable systems use high temperature resistant rubber cables which ensure leak free terminations

### Hyperflex™ Cable Systems

- Air cooled cable assemblies offer outstanding flexibility and the highest heat and abrasion resistance of any known cable
- Cable end crimp systems ensure maximum conductivity whilst the outer jacket is constructed from cross linked polymers providing a tear proof jacket and a burn threshold of 375°C

### Machine End Systems

- Extra length cable support systems
- Smooth and consistent wire feed
- Simple snap fits

### Gun Plug Bodies

- Spring loaded pins
- Guaranteed gas seals

### Quality Standards

All torches are rigorously tested using computerised and automated test equipment at the design stage through to production. All our components pass rigorous quality control checks prior to assembly. All torches are designed to be tough and damage resistant and comply with EN60974-7.

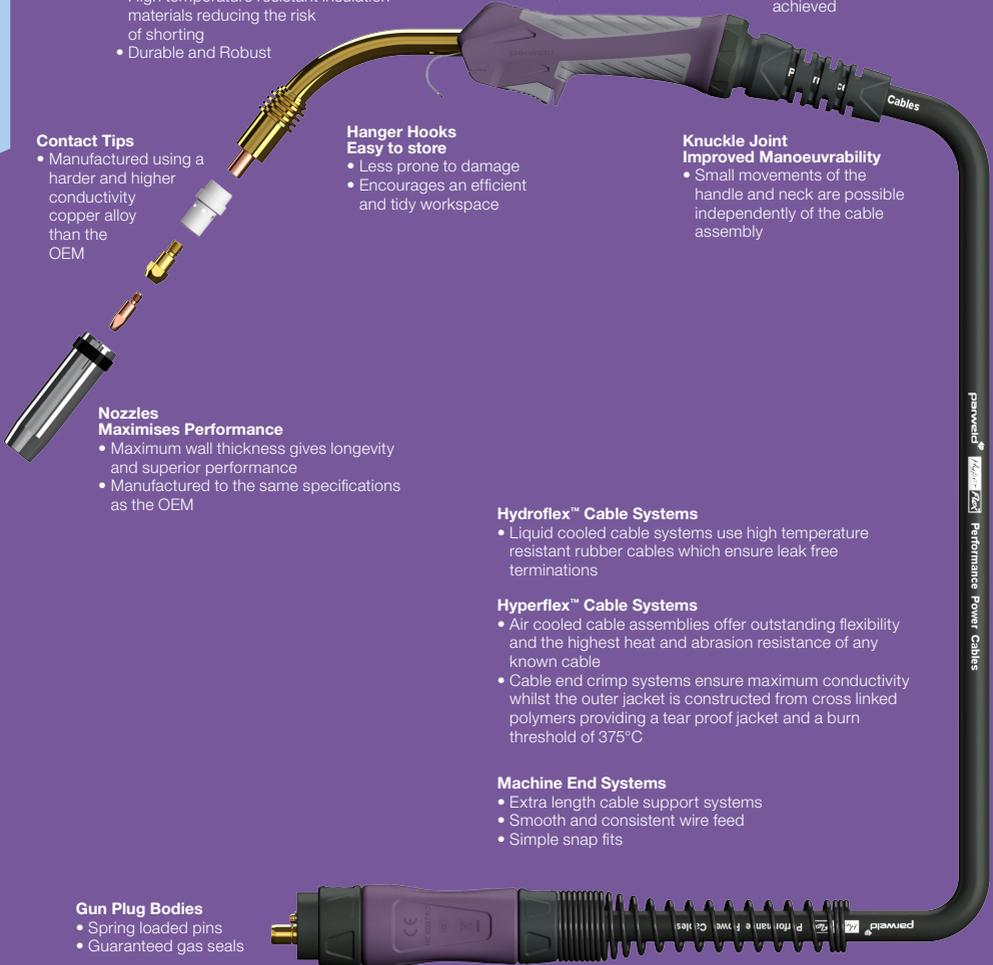

# BZL Eco-Grip Max® Features and Benefits

### Swan

- High temperature resistant insulation materials reducing the risk of shorting
- Durable and Robust

### Eco-Grip Max® Handle System Maximises user comfort

- Designed for balance, lightness and strength
- Enhances wire feeding performance
- Screwless design for rapid servicing

### Cable Supports Improved Wire Feed

- The perfect balance of freedom of movement and progressive support to the power cable is achieved

### Contact Tips

- Manufactured using a hard and high conductivity copper alloy

### Knuckle Joint Improved Manoeuvrability

- Small movements of the handle and neck are possible independently of the cable assembly

### Nozzles

#### Maximises Performance

- Gives longevity and superior performance

### Hydroflex™ Cable Systems

- Liquid cooled cable systems use high temperature resistant rubber cables which ensure leak free terminations

### Hyperflex™ Cable Systems

- Air cooled cable assemblies offer outstanding flexibility and the highest heat and abrasion resistance of any known cable
- Cable end crimp systems ensure maximum conductivity whilst the outer jacket is constructed from cross linked polymers providing a tear proof jacket and a burn threshold of 375°C

### Machine End Systems

- Extra length cable support systems
- Smooth and consistent wire feed
- Simple snap fits

### Gun Plug Bodies

- Spring loaded pins
- Guaranteed gas seals

### Quality Standards

All torches are rigorously tested using computerised and automated test equipment at the design stage through to production. All our components pass rigorous quality control checks prior to assembly. All torches are designed to be tough and damage resistant and comply with EN60974-7.



## BZL Nozzles

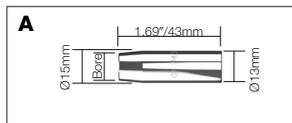

Stock Code	Description	Bore Size	Model
A B1430-P	Conical	11mm/7/16"	SB120A

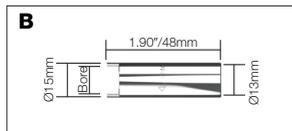

Stock Code	Description	Bore Size	Model
B B1430-S	Spot Push On	13mm/1/2"	SB120A

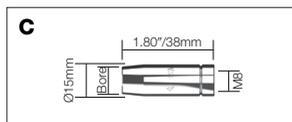

Stock Code	Description	Bore Size	Model
C B1430	Conical Screw	11mm/7/16"	SB120A
B1430L	Conical Long	11mm/7/16"	SB120A

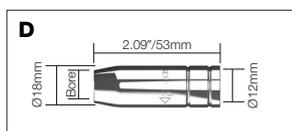

Stock Code	Description	Bore Size	Model
D B1529	Cylindrical	16mm/5/8"	SB140A, SB150A
B1530	Conical	12mm/15/32"	SB140A, SB150A
ECO1530	Everyday Conical	12mm/15/32"	ECR150A
B1531	Tapered	11mm/7/16"	SB140A, SB150A

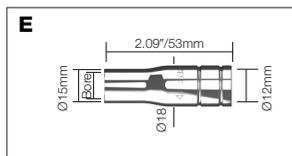

Stock Code	Description	Bore Size	Model
E B1532	Bottle	13mm/1/2"	SB140A, SB150A

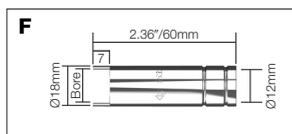

Stock Code	Description	Bore Size	Model
F B1533	Spot	16mm/5/8"	SB140A, SB150A

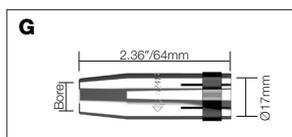

Stock Code	Description	Bore Size	Model
G B2415	Cylindrical	17mm/11/16"	SB230A, SB240A, SB240W
B2416	Conical	13mm/1/2"	SB230A, SB240A, SB240W
B2417	Tapered	10mm/3/8"	SB230A, SB240A, SB240W

## Roll Marking

All Parweld consumables are roll marked to enable you to identify genuine Parweld product.

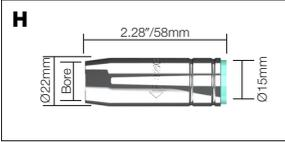

Stock Code	Description	Bore Size	Model
H B2507	Cylindrical	18mm/5/7"	SB250A, SB350W
B2508	Conical	15mm/19/32"	SB250A, SB350W
B2509	Tapered	12mm/15/32"	SB250A, SB350W
ECO2507	Everyday Cylindrical	18mm/5/7"	ECR250A
ECO2508	Everyday Conical	15mm/19/32"	ECR250A
ECO2509	Everyday Tapered	12mm/15/32"	ECR250A

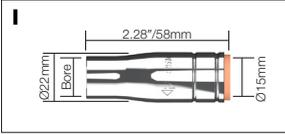

Stock Code	Description	Bore Size	Model
I B2510	Bottle	15mm/19/32"	SB250A, SB350W

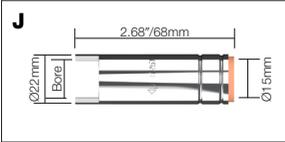

Stock Code	Description	Bore Size	Model
J B2511	Spot	18mm/5/7"	SB250A, SB350W



Stock Code	Description	Bore Size	Model
K B3615	Cylindrical	19mm/3/4"	SB360A
B3616	Conical	16mm/5/8"	SB360A
B3617	Tapered	12mm/15/32"	SB360A
ECO3615	Everyday Cylindrical	19mm/3/4"	ECR360A
ECO3616	Everyday Conical	16mm/5/8"	ECR360A
ECO3617	Everyday Tapered	12mm/15/32"	ECR360A

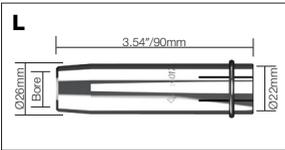

Stock Code	Description	Bore Size	Model
L B4017	Conical	18mm/5/7"	SB400A



Stock Code	Description	Bore Size	Model
M B5027	Cylindrical	19mm/3/4"	SB380A-501W
B5028	Conical	16mm/5/8"	SB380A-501W
B5029	Tapered	14mm/9/16"	SB380A-501W
ECO5027	Everyday Cylindrical	19mm/3/4"	ECR501W
ECO5028	Everyday Conical	16mm/5/8"	ECR501W
ECO5029	Everyday Tapered	14mm/9/16"	ECR501W



Stock Code	Description	Bore Size	Model
N B5028HD	HD Conical	16mm/5/8"	SB380A-501W

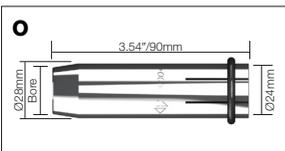

Stock Code	Description	Bore Size	Model
O B6004	Conical	20mm/25/32"	SB610A, SB610W
B6005	Cylindrical	23mm/29/32"	SB610A, SB610W

## BZL Contact Tips

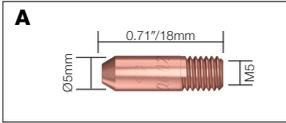

Stock Code	Description	Wire Size	Material	Model
A B1427-06	Contact Tip	0.6mm/.023"	ECu	SB120A
B1427-08	Contact Tip	0.8mm/.030"	ECu	SB120A
B1427-10	Contact Tip	1.0mm/.040"	ECu	SB120A

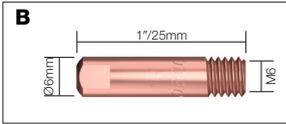

Stock Code	Description	Wire Size	Material	Model
B B1527-06	Contact Tip	0.6mm/.023"	ECu	SB140A, SB150A
ECO1527-06	Everyday Tip	0.6mm/.023"	ECu	SB140A, SB150A
B1527-08	Contact Tip	0.8mm/.030"	ECu	SB140A, SB150A
ECO1527-08	Everyday Tip	0.8mm/.030"	ECu	SB140A, SB150A
B1527-09	Contact Tip	0.9mm/.035"	ECu	SB140A, SB150A
B1527-10	Contact Tip	1.0mm/.040"	ECu	SB140A, SB150A
B1527-12	Contact Tip	1.2mm/.045"	ECu	SB140A, SB150A

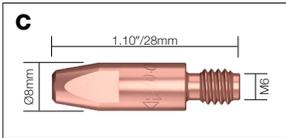

Stock Code	Description	Wire Size	Material	Model
C B2504-06	Contact Tip	0.6mm/.023"	ECu	SB230A-350W
B2504-08	Contact Tip	0.8mm/.030"	ECu	SB230A-350W
ECO2504-08	Everyday Tip	0.8mm/.030"	ECu	SB230A-350W
B2504-09	Contact Tip	0.9mm/.035"	ECu	SB230A-350W
B2504-10	Contact Tip	1.0mm/.040"	ECu	SB230A-350W
ECO2504-10	Everyday Tip	1.0mm/.040"	ECu	SB230A-350W
B2504-12	Contact Tip	1.2mm/.045"	ECu	SB230A-350W
ECO2504-12	Everyday Tip	1.2mm/.045"	ECu	SB230A-350W
B2504-14	Contact Tip	1.4mm/.055"	ECu	SB230A-350W
B2504-16	Contact Tip	1.6mm/1/16"	ECu	SB230A-350W
B2504-08CR	Contact Tip CR	0.8mm/.030"	ECu	SB230A-350W
B2504-10CR	Contact Tip CR	1.0mm/.040"	ECu	SB230A-350W
B2504-12CR	Contact Tip CR	1.2mm/.045"	ECu	SB230A-350W
B2504-10A	Contact Tip Al	1.0mm/.040"	ECu	SB230A-350W
B2504-12A	Contact Tip Al	1.2mm/.045"	ECu	SB230A-350W
B2504-16A	Contact Tip Al	1.6mm/1/16"	ECu	SB230A-350W

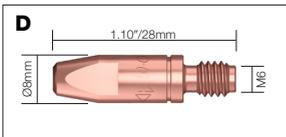

Stock Code	Description	Wire Size	Material	Model
D B2505-08	Contact Tip	0.8mm/.030"	CuCrZr	SB230A-350W
ECO2505-08	Everyday Tip	0.8mm/.030"	CuCrZr	SB230A-350W
B2505-09	Contact Tip	0.9mm/.035"	CuCrZr	SB230A-350W
B2505-10	Contact Tip	1.0mm/.040"	CuCrZr	SB230A-350W
ECO2505-10	Everyday Tip	1.0mm/.040"	CuCrZr	SB250A
B2505-12	Contact Tip	1.2mm/.045"	CuCrZr	SB230A-350W
ECO2505-12	Everyday Tip	1.2mm/.045"	CuCrZr	SB250A
B2505-16	Contact Tip	1.6mm/1/16"	CuCrZr	SB230A-350W

## Roll Marking

All Parweld consumables are roll marked to enable you to identify genuine Parweld product.

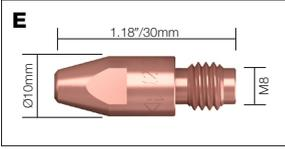

Stock Code	Description	Wire Size	Material	Model
E B4014-08	Contact Tip	0.8mm/.030"	ECu	SB360A-SB501W
B4014-09	Contact Tip	0.9mm/.035"	ECu	SB360A-SB501W
B4014-10	Contact Tip	1.0mm/.040"	ECu	SB360A-SB501W
ECO4014-10	Everyday Tip	1.0mm/.040"	ECu	SB360A-SB501W
B4014-12	Contact Tip	1.2mm/.045"	ECu	SB360A-SB501W
ECO4014-12	Everyday Tip	1.2mm/.045"	ECu	SB360A-SB501W
B4014-14	Contact Tip	1.4mm/.055"	ECu	SB360A-SB501W
B4014-16	Contact Tip	1.6mm/1/16"	ECu	SB360A-SB501W
ECO4014-16	Everyday Tip	1.6mm/1/16"	ECu	SB360A-SB501W
B4014-20	Contact Tip	2.0mm/5/64"	ECu	SB360A-SB501W
B4014-24	Contact Tip	2.4mm/3/32"	ECu	SB360A-SB501W
B4014-10CR	Contact Tip CR	1.0mm/.040"	ECu	SB360A-SB501W
B4014-12CR	Contact Tip CR	1.2mm/.045"	ECu	SB360A-SB501W
B4014-10A	Contact Tip Al	1.0mm/.040"	ECu	SB360A-SB501W
B4014-12A	Contact Tip Al	1.2mm/.045"	ECu	SB360A-SB501W
B4014-16A	Contact Tip Al	1.6mm/1/16"	ECu	SB360A-SB501W

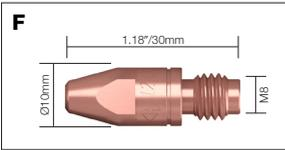

Stock Code	Description	Wire Size	Material	Model
F B4015-08	Contact Tip	0.8mm/.030"	CuCrZr	SB360A-SB501W
B4015-10	Contact Tip	1.0mm/.040"	CuCrZr	SB360A-SB501W
B4015-12	Contact Tip	1.2mm/.045"	CuCrZr	SB360A-SB501W
B4015-14	Contact Tip	1.4mm/.055"	CuCrZr	SB360A-SB501W
B4015-16	Contact Tip	1.6mm/1/16"	CuCrZr	SB360A-SB501W
B4015-24	Contact Tip	2.4mm/3/32"	CuCrZr	SB360A-SB501W

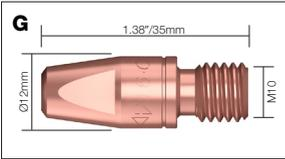

Stock Code	Description	Wire Size	Material	Model
G B6015-14	Contact Tip	1.4mm/.055"	CuCrZr	SB610A, SB610W
B6015-16	Contact Tip	1.6mm/1/16"	CuCrZr	SB610A, SB610W
B6015-20	Contact Tip	2.0mm/5/64"	CuCrZr	SB610A, SB610W
B6015-24	Contact Tip	2.4mm/3/32"	CuCrZr	SB610A, SB610W
B6015-28	Contact Tip	2.8mm/7/64"	CuCrZr	SB610A, SB610W
B6015-32	Contact Tip	3.2mm/1/8"	CuCrZr	SB610A, SB610W

## BZL Tip Adaptors

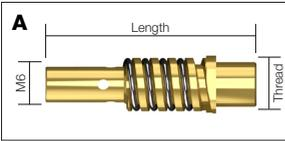

Stock Code	Description	Tip Thread	Neck Thread	Length	Model
A B1507 L/H	Tip Adaptor	M6	M8x1 L/H	42mm/1.65"	SB150A
B1507	Tip Adaptor	M6	M8x1	34mm/1.34"	SB140A

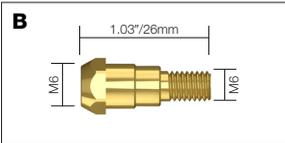

Stock Code	Description	Tip Thread	Neck Thread	Model
B B2412	Tip Adaptor	M6	M6	SB230A, SB240A/W

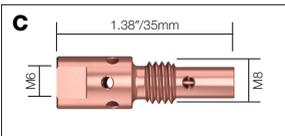

Stock Code	Description	Tip Thread	Neck Thread	Model
C B2506	Tip Adaptor	M6	M8	SB250A, SB350W
ECO2506	Everyday Adaptor	M6	M8	SB250A, SB350W

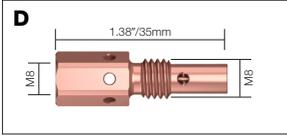

Stock Code	Description	Tip Thread	Neck Thread	Model
D B2536	Tip Adaptor	M8	M8	SB250A, SB350W

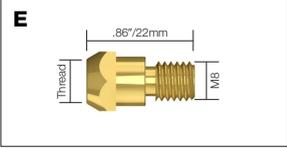

Stock Code	Description	Tip Thread	Neck Thread	Model
E B2612	Tip Adaptor	M6	M8	SB260A
B2612M8	Tip Adaptor	M8	M8	SB260A

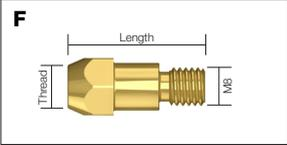

Stock Code	Description	Tip Thread	Neck Thread	Length	Model
F B3612	Tip Adaptor	M6	M8	28.5mm/1.12"	SB360A
ECO3612	Everyday Adaptor	M6	M8	28.5mm/1.12"	SB360A
B3613	Tip Adaptor	M6	M8	31.5mm/1.24"	SB360A
B3614	Tip Adaptor	M8	M8	28.5mm/1.12"	SB360A
ECO3614	Everyday Adaptor	M8	M8	28.5mm/1.12"	SB360A

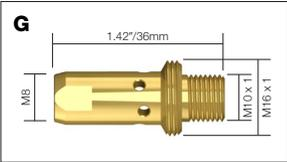

Stock Code	Description	Tip Thread	Neck Thread	Model
G B3812	Tip Adaptor	M8	M10 x 1	SB380A



Stock Code	Description	Tip Thread	Neck Thread	Model
H B4005	Tip Adaptor	M8	M8	SB400A

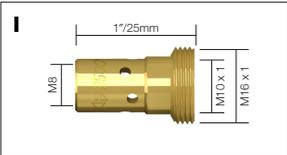

Stock Code	Description	Tip Thread	Neck Thread	Model
I B5001	Tip Adaptor	M8	M10 x 1	SB401W, SB501W
ECO5001	Everyday Adaptor	M8	M10 x 1	SB401W, SB501W

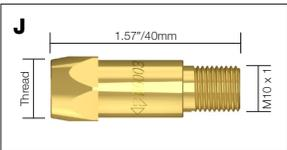

Stock Code	Description	Tip Thread	Neck Thread	Model
J B6003	Tip Adaptor	M8	M10 x 1	SB610A, SB610W
B6003M10	Tip Adaptor	M10	M10 x 1	SB610A, SB610W

### Roll Marking

All Parweld consumables are roll marked to enable you to identify genuine Parweld product.

## BZL Gas Diffusers

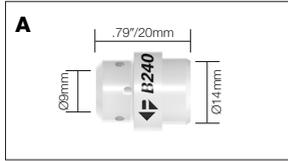

Stock Code	Description	Colour	Model
A B2405B	Gas Diffuser	Black	SB240A, SB240W
B2405C	Gas Diffuser	Ceramic	SB240A, SB240W
B2405W	Gas Diffuser	White	SB240A, SB240W

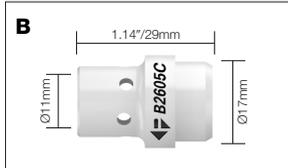

Stock Code	Description	Colour	Model
B B2605B	Gas Diffuser	Black	SB260A
B2605C	Gas Diffuser	Ceramic	SB260A
B2605W	Gas Diffuser	White	SB260A

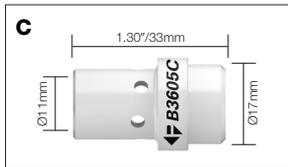

Stock Code	Description	Colour	Model
C B3605B	Gas Diffuser	Black	SB360A
B3605C	Gas Diffuser	Ceramic	SB360A
B3605W	Gas Diffuser	White	SB360A

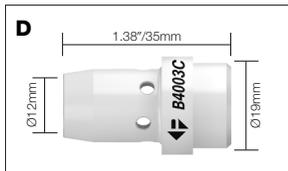

Stock Code	Description	Colour	Model
D B4003B	Gas Diffuser	Black	SB400A
B4003C	Gas Diffuser	Ceramic	SB400A

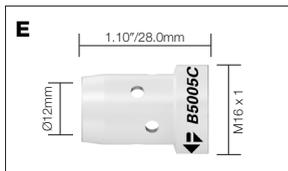

Stock Code	Description	Colour	Model
E B5005B	Gas Diffuser	Black	SB380A, SB401W, SB501W
B5005C	Gas Diffuser	Ceramic	SB380A, SB401W, SB501W
B5005W	Gas Diffuser	White	SB380A, SB401W, SB501W

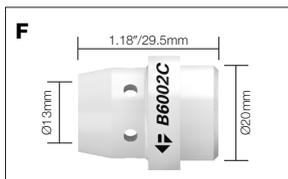

Stock Code	Description	Colour	Model
F B6002C	Gas Diffuser	Ceramic	SB610A, SB610W

## Roll Marking

All Parweld consumables are roll marked to enable you to identify genuine Parweld product.

# BZL Liner Selector Chart

Model	Stock Code	Description	Length	Wire Size	Colour Code															
					SB120A	SB140A	SB150A	SB230A	SB240A	SB250A	SB260A	SB360A	SB380A	SB400A	SB610A	SB230W	SB401W	SB501W	SB610W	
A	B1435-30	Steel Liner	3m	.023"-.035"/0.6mm-0.8mm	■	□	□	□	□	□	□	□	□	□	□	□	□	□	□	
	B1435-40	Steel Liner	4m	.023"-.035"/0.6mm-0.8mm	■	□	□	□	□	□	□	□	□	□	□	□	□	□	□	
	B1435-20TEL	Steel Liner (Telwin)	2m	.023"-.030"/0.6mm-0.8mm	■	□	□	□	□	□	□	□	□	□	□	□	□	□	□	
	B1435-30TEL	Steel Liner (Telwin)	3m	.023"-.030"/0.6mm-0.8mm	■	□	□	□	□	□	□	□	□	□	□	□	□	□	□	
B	B1436-30	Nylon Liner	3m	.023"-.035"/0.6mm-0.9mm	■	□	□	□	□	□	□	□	□	□	□	□	□	□	□	
	B1436-40	Nylon Liner	4m	.023"-.035"/0.6mm-0.9mm	■	□	□	□	□	□	□	□	□	□	□	□	□	□	□	
	ECO / B1535-30	Steel Liner	3m	.023"-.035"/0.6mm-0.9mm	■	■	■	■	■	■	■	■	■	■	■	■	■	■	■	
	ECO / B1535-40	Steel Liner	4m	.023"-.035"/0.6mm-0.9mm	■	■	■	■	■	■	■	■	■	■	■	■	■	■	■	
C	B1535-50++	Steel Liner	5m	.023"-.035"/0.6mm-0.9mm	■	■	■	■	■	■	■	■	■	■	■	■	■	■	■	
	B1535-20TEL	Steel Liner (Telwin)	2m	.023"-.035"/0.6mm-0.9mm	■	■	□	□	□	□	□	□	□	□	□	□	□	□	□	
	B1535-30TEL	Steel Liner (Telwin)	3m	.023"-.035"/0.6mm-0.9mm	■	■	□	□	□	□	□	□	□	□	□	□	□	□	□	
	B1536-30++	Teflon Liner	3m	.023"-.035"/0.6mm-0.9mm	■	■	■	■	■	■	■	■	■	■	■	■	■	■	■	■
B	B1536-40++	Teflon Liner	4m	.023"-.035"/0.6mm-0.9mm	■	■	■	■	■	■	■	■	■	■	■	■	■	■	■	■
	B1536-50++	Teflon Liner	5m	.023"-.035"/0.6mm-0.9mm	■	■	■	■	■	■	■	■	■	■	■	■	■	■	■	■
	ECO / B2524-30	Steel Liner	3m	.040"-.045"/1.0mm-1.2mm	□	□	□	□	□	□	□	□	□	□	□	□	□	□	□	□
	ECO / B2524-40	Steel Liner	4m	.040"-.045"/1.0mm-1.2mm	□	□	□	□	□	□	□	□	□	□	□	□	□	□	□	□
C	B2524-50	Steel Liner	5m	.040"-.045"/1.0mm-1.2mm	□	□	□	□	□	□	□	□	□	□	□	□	□	□	□	□
	B2513-30++	Teflon Liner	3m	.040"-.045"/1.0mm-1.2mm	□	□	□	□	□	□	□	□	□	□	□	□	□	□	□	□
	B2513-40++	Teflon Liner	4m	.040"-.045"/1.0mm-1.2mm	□	□	□	□	□	□	□	□	□	□	□	□	□	□	□	□
	B2513-50++	Teflon Liner	5m	.040"-.045"/1.0mm-1.2mm	□	□	□	□	□	□	□	□	□	□	□	□	□	□	□	□
B	B3631-30	Steel Liner	3m	1/16"/1.6mm	□	□	□	□	□	□	□	□	□	□	□	□	□	□	□	□
	B3631-40	Steel Liner	4m	1/16"/1.6mm	□	□	□	□	□	□	□	□	□	□	□	□	□	□	□	□
	B3631-50	Steel Liner	5m	1/16"/1.6mm	□	□	□	□	□	□	□	□	□	□	□	□	□	□	□	□
	C	B3626-30++	Teflon Liner	3m	.045"-.1/16"/1.2mm-1.6mm	□	□	□	□	□	□	□	□	□	□	□	□	□	□	□
B3626-40++		Teflon Liner	4m	.045"-.1/16"/1.2mm-1.6mm	□	□	□	□	□	□	□	□	□	□	□	□	□	□	□	□
B3626-50++		Teflon Liner	5m	.045"-.1/16"/1.2mm-1.6mm	□	□	□	□	□	□	□	□	□	□	□	□	□	□	□	□
B		B4631-30	Steel Liner	3m	5/64"-3/32"/2.0mm-2.4mm	□	□	□	□	□	□	□	□	□	□	□	□	□	□	□
	B4631-40	Steel Liner	4m	5/64"-3/32"/2.0mm-2.4mm	□	□	□	□	□	□	□	□	□	□	□	□	□	□	□	□
	B4631-50	Steel Liner	5m	5/64"-3/32"/2.0mm-2.4mm	□	□	□	□	□	□	□	□	□	□	□	□	□	□	□	□
	D	B6033-30	Plain Liner (Rz-2)	3m	1/16"-5/64"/1.6mm-2.0mm	□	□	□	□	□	□	□	□	□	□	□	□	□	□	□
B6033-40		Plain Liner (Rz-2)	4m	1/16"-5/64"/1.6mm-2.0mm	□	□	□	□	□	□	□	□	□	□	□	□	□	□	□	□
B6033-50		Plain Liner (Rz-2)	5m	1/16"-5/64"/1.6mm-2.0mm	□	□	□	□	□	□	□	□	□	□	□	□	□	□	□	□
D		B6034-30	Plain Liner (Rz-2)	3m	3/32"/2.4mm	□	□	□	□	□	□	□	□	□	□	□	□	□	□	□
	B6034-40	Plain Liner (Rz-2)	4m	3/32"/2.4mm	□	□	□	□	□	□	□	□	□	□	□	□	□	□	□	□
	B6035-30	Plain Liner (Rz-2)	3m	.110"-1/8"/2.8mm-3.2mm	□	□	□	□	□	□	□	□	□	□	□	□	□	□	□	□
	B6035-40	Plain Liner (Rz-2)	4m	.110"-1/8"/2.8mm-3.2mm	□	□	□	□	□	□	□	□	□	□	□	□	□	□	□	□
B	B5033-30	Plain Liner	3m	.040"-.045"/1.0mm-1.2mm	□	□	□	□	□	□	□	□	□	□	□	□	□	□	□	□
	B5033-40	Plain Liner	4m	.040"-.045"/1.0mm-1.2mm	□	□	□	□	□	□	□	□	□	□	□	□	□	□	□	□
	B5033-50	Plain Liner	5m	.040"-.045"/1.0mm-1.2mm	□	□	□	□	□	□	□	□	□	□	□	□	□	□	□	□
	B	B5034-30	Plain Liner	3m	.045"-.1/16"/1.2mm-1.6mm	□	□	□	□	□	□	□	□	□	□	□	□	□	□	□
B5034-40		Plain Liner	4m	.045"-.1/16"/1.2mm-1.6mm	□	□	□	□	□	□	□	□	□	□	□	□	□	□	□	□
B5034-50		Plain Liner	5m	.045"-.1/16"/1.2mm-1.6mm	□	□	□	□	□	□	□	□	□	□	□	□	□	□	□	□
A		B4033-30	Plain Liner	3m	5/64"-3/32"/2.0mm-2.4mm	□	□	□	□	□	□	□	□	□	□	□	□	□	□	□
	B4033-40	Plain Liner	4m	5/64"-3/32"/2.0mm-2.4mm	□	□	□	□	□	□	□	□	□	□	□	□	□	□	□	□
	B4033-50	Plain Liner	5m	5/64"-3/32"/2.0mm-2.4mm	□	□	□	□	□	□	□	□	□	□	□	□	□	□	□	□
	C	B1564-30++	Polyamide Liner	3m	.030"-.045"/0.8mm-1.2mm	■	■	■	■	■	■	■	■	■	■	■	■	■	■	■
B1564-40++		Polyamide Liner	4m	.030"-.045"/0.8mm-1.2mm	■	■	■	■	■	■	■	■	■	■	■	■	■	■	■	■
B1564-50++		Polyamide Liner	5m	.030"-.045"/0.8mm-1.2mm	■	■	■	■	■	■	■	■	■	■	■	■	■	■	■	■
C		B2564-30++	Polyamide Liner	3m	.045"-.1/16"/1.2mm-1.6mm	□	□	□	□	□	□	□	□	□	□	□	□	□	□	□
	B2564-40++	Polyamide Liner	4m	.045"-.1/16"/1.2mm-1.6mm	□	□	□	□	□	□	□	□	□	□	□	□	□	□	□	□
	B2564-50++	Polyamide Liner	5m	.045"-.1/16"/1.2mm-1.6mm	□	□	□	□	□	□	□	□	□	□	□	□	□	□	□	□
	C	B3564-30++	Polyamide Liner	3m	1/16"-5/64"/1.6mm-2.0mm	□	□	□	□	□	□	□	□	□	□	□	□	□	□	□
B3564-40++		Polyamide Liner	4m	1/16"-5/64"/1.6mm-2.0mm	□	□	□	□	□	□	□	□	□	□	□	□	□	□	□	□
B3564-50++		Polyamide Liner	5m	1/16"-5/64"/1.6mm-2.0mm	□	□	□	□	□	□	□	□	□	□	□	□	□	□	□	□
C		B2554-30++	Carbon Teflon Liner	3m	.040"-.045"/1.0mm-1.2mm	■	■	■	■	■	■	■	■	■	■	■	■	■	■	■
	B2554-40++	Carbon Teflon Liner	4m	.040"-.045"/1.0mm-1.2mm	■	■	■	■	■	■	■	■	■	■	■	■	■	■	■	■
	B2554-50++	Carbon Teflon Liner	5m	.040"-.045"/1.0mm-1.2mm	■	■	■	■	■	■	■	■	■	■	■	■	■	■	■	■
	C	B3554-30++	Carbon Teflon Liner	3m	.045"-.1/16"/1.2mm-1.6mm	□	□	□	□	□	□	□	□	□	□	□	□	□	□	□
B3554-40++		Carbon Teflon Liner	4m	.045"-.1/16"/1.2mm-1.6mm	□	□	□	□	□	□	□	□	□	□	□	□	□	□	□	□
B3554-50++		Carbon Teflon Liner	5m	.045"-.1/16"/1.2mm-1.6mm	□	□	□	□	□	□	□	□	□	□	□	□	□	□	□	□

■ Solid Box = Recommended Liner  
 □ Clear Box = Compatible Liner

++ For optional Neck Liners please use the following codes.  
 B9000 for soft wires .030"-.045"/0.8mm-1.0mm, B9001 for .040"-.1/16"/1.0mm-1.6mm

**Colour Code**  
 0.6-0.9mm Wire ■ Blue      1.2-1.6mm Wire ■ Yellow  
 1.0-1.2mm Wire ■ Red      2.0-2.4mm Wire ■ Green

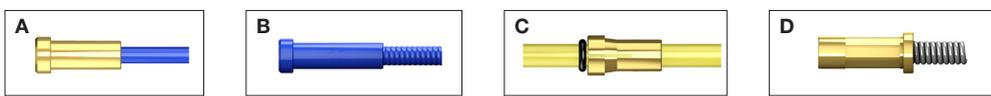

# Eco-Grip Max<sup>®</sup> 150A

## Air Cooled MIG Torch

140A CO<sub>2</sub>, 140A Mixed Gas @ 60% Duty Cycle, EN60974-7 .023"- .040"/0.6mm to 1.0mm Wires

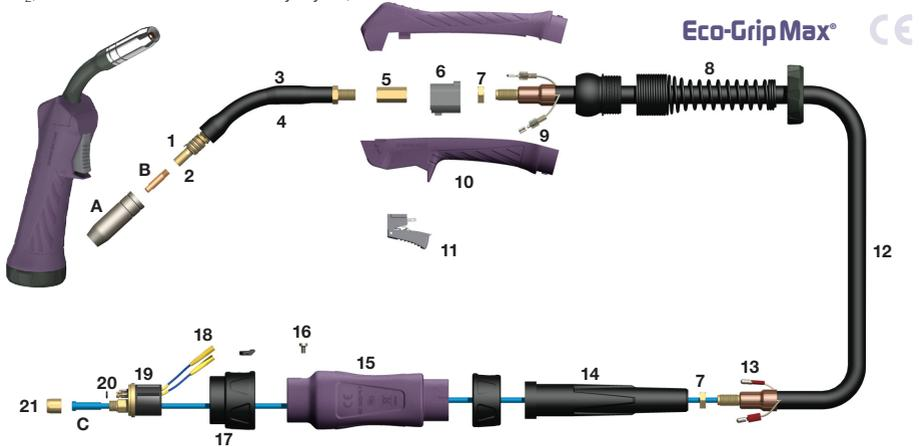

### Model

Stock Code	Description
ECR1500-30ER	Eco-Grip Max <sup>®</sup> Torch Package c/w Euro Fitting x 3m
ECR1500-40ER	Eco-Grip Max <sup>®</sup> Torch Package c/w Euro Fitting x 4m

### Nozzles

Stock Code	Description
A ECO1530*	Everyday Conical Nozzle 15/32"/12mm Bore
B1529	Everyday Cylindrical Nozzle 5/8"/16mm Bore
B1531	Everyday Tapered Nozzle 7/16"/11mm Bore
B1532	Everyday Bottle Nozzle 1/2"/13mm Bore
B1533	Everyday Spot Welding Nozzle 5/8"/16mm Bore

### Contact Tips

Stock Code	Description
B ECO1527-06	Everyday Contact Tip .023"/0.6mm M6 ECu
ECO1527-08*	Everyday Contact Tip .030"/0.8mm M6 ECu

### Liners

Stock Code	Description
C ECO1535-30	Everyday Steel Liner .023"- .030"/0.6-0.9mm x 3m
ECO1535-40	Everyday Steel Liner .023"- .030"/0.6-0.9mm x 4m

### Components

\* Denotes Standard Build

Stock Code	Description
1 B1504	Shroud Spring
2 B1507 L/H	Tip Adaptor M6
3 ECO1501	Swan Neck c/w Tip Adaptor and Insulation Sleeve
4 ECO1502	One Piece Neck Insulation Sleeve
5 B2519	Hexagonal Fitting
6 B1515/PG	Handle Location Body
7 B1505	Lock Nut
8 ECO8020	Spring Cable Support
9 B1521	Cable Terminal-Female
10 ECO8514	Eco-Grip Max <sup>®</sup> Handle Kit
11 B8516	Eco-Grip Max <sup>®</sup> Trigger
12 B1517-30	Cable Assembly x 3m/10ft
B1517-40	Cable Assembly x 4m/13ft
B1517-50	Cable Assembly x 5m/16ft
13 B1522	Cable Terminal-Male
14 B1841	Cable Support
15 B1518	Gun Plug Housing c/w Nut
16 B1526	Gun Plug Screw
17 B1519/PL	Gun Plug Nut-Plastic c/w Insert
18 Spring Pin 2	Spring Pin Assembly
19 ECB1528	Gun Plug Body c/w Spring Pins
20 B1524	Gun Plug 'O' Ring
21 B1525	Liner Nut

# Eco-Grip Max<sup>®</sup> 240A

## Air Cooled MIG Torch

200A CO<sub>2</sub>, 170A Mixed Gas @ 60% Duty Cycle, EN60974-7 .030"- .045"/0.8mm to 1.2mm Wires

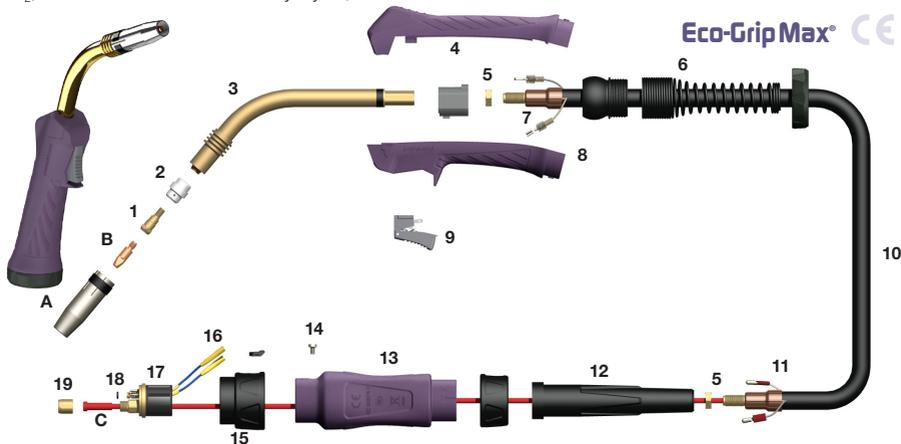

### Models

Stock Code	Description
ECR2400-30ER	Eco-Grip Max <sup>®</sup> Welding Torch c/w Euro Fitting x 3m
ECR2400-40ER	Eco-Grip Max <sup>®</sup> Welding Torch c/w Euro Fitting x 4m
ECR2400-50ER	Eco-Grip Max <sup>®</sup> Welding Torch c/w Euro Fitting x 5m

### Nozzles

Stock Code	Description
A B2415	Cylindrical Nozzle 11/16"/17mm Bore
B2416*	Conical Nozzle 1/2"/13mm Bore
B2417	Tapered Nozzle 3/8"/10mm Bore

### Contact Tips

Stock Code	Description
B ECO2504-08	Contact Tip .030"/0.8mm M6 Ecu
ECO2504-10*	Contact Tip .040"/1.0mm M6 Ecu
ECO2504-12	Contact Tip .045"/1.2mm M6 Ecu
ECO2505-08	Contact Tip .030"/0.8mm M6 CuCrZr
ECO2505-10	Contact Tip .040"/1.0mm M6 CuCrZr
ECO2505-12	Contact Tip .045"/1.2mm M6 CuCrZr

### Liners

Stock Code	Description
C ECO1535-30	Steel Liner .023"- .035"/0.6mm-0.9mm x 3m
ECO1535-40	Steel Liner .023"- .035"/0.6mm-0.9mm x 4m
ECO1535-50	Steel Liner .023"- .035"/0.6mm-0.9mm x 5m
ECO2524-30*	Steel Liner .040"- .045"/1.0mm-1.2mm x 3m
ECO2524-40*	Steel Liner .040"- .045"/1.0mm-1.2mm x 4m
ECO2524-50*	Steel Liner .040"- .045"/1.0mm-1.2mm x 5m
B1536-30	Teflon Liner .023"- .035"/0.6mm-0.9mm x 3m
B1536-40	Teflon Liner .023"- .035"/0.6mm-0.9mm x 4m
B1536-50	Teflon Liner .023"- .035"/0.6mm-0.9mm x 5m
B2513-30	Teflon Liner .040"- .045"/1.0mm-1.2mm x 3m
B2513-40	Teflon Liner .040"- .045"/1.0mm-1.2mm x 4m
B2513-50	Teflon Liner .040"- .045"/1.0mm-1.2mm x 5m

### Components

\* Denotes Standard Build

Stock Code	Description
1 B2412	Tip Adaptor M6
2 B2405B	Diffuser Black
B2405C*	Diffuser Ceramic
2 B2405W	Diffuser White
3 ECO2401	Swan Neck
4 B1515/PG	Handle Location Body
5 B1505	Lock Nut
6 B8015	Cable Support c/w Knuckle Joint
7 B1521	Cable Terminal
8 ECO8514	Eco-Grip Max <sup>®</sup> Handle Kit
9 B8516	Eco-Grip Max <sup>®</sup> Trigger
10 B2603-30	Cable Assembly x 3m/10ft
B2603-40	Cable Assembly x 4m/13ft
B2603-50	Cable Assembly x 5m/16ft
11 B1522	Cable Terminal-Male
12 B2841	Cable Support
13 B1518	Gun Plug Housing c/w Nut
14 B1526	Gun Plug Screw
15 B1519	Gun Plug Nut c/w Insert
16 Spring Pin 2	Spring Pin Assembly
17 ECB1528	Gun Plug Body c/w Spring Pins
18 B1524	Gun Plug 'O' Ring
19 B1525	Liner Nut

# Eco-Grip Max<sup>®</sup> 250A

## Air Cooled MIG Torch

184A CO<sub>2</sub>, 160A Mixed Gas @ 60% Duty Cycle, EN60974-7 .030"- .045"/0.8mm to 1.2mm Wires

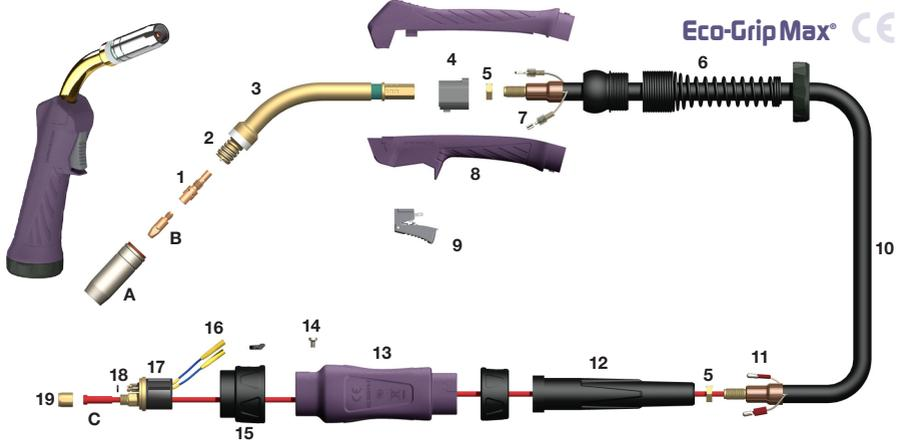

### Models

Stock Code	Description
ECR2500-30ER	Eco-Grip Max <sup>®</sup> Torch Package c/w Euro Fitting x 3m
ECR2500-40ER	Eco-Grip Max <sup>®</sup> Torch Package c/w Euro Fitting x 4m
ECR2500-50ER	Eco-Grip Max <sup>®</sup> Torch Package c/w Euro Fitting x 5m

### Nozzles

Stock Code	Description
A ECO2507	Everyday Cylindrical Nozzle 5/7"/18mm Bore
ECO2508*	Everyday Conical Nozzle 19/32"/15mm Bore
ECO2509	Everyday Tapered Nozzle 15/32"/12mm Bore

### Contact Tips

Stock Code	Description
B ECO2504-08*	Everyday Contact Tip .030"/0.8mm M6 ECu
ECO2504-10	Everyday Contact Tip .040"/1.0mm M6 ECu
ECO2504-12	Everyday Contact Tip .045"/1.2mm M6 ECu
ECO2505-08	Everyday Contact Tip .030"/0.8mm M6 CuCrZr
ECO2505-10	Everyday Contact Tip .040"/1.0mm M6 CuCrZr
ECO2505-12	Everyday Contact Tip .045"/1.2mm M6 CuCrZr

### Liners

Stock Code	Description
C ECO1535-30	Everyday Steel Liner .023"-.035"/0.6-0.9mm x 3m
ECO1535-40	Everyday Steel Liner .023"-.035"/0.6-0.9mm x 4m
ECO1535-50	Everyday Steel Liner .023"-.035"/0.6-0.9mm x 5m
ECO2524-30*	Everyday Steel Liner .040"-.045"/1.0-1.2mm x 3m
ECO2524-40*	Everyday Steel Liner .040"-.045"/1.0-1.2mm x 4m
ECO2524-50*	Everyday Steel Liner .040"-.045"/1.0-1.2mm x 5m

### Components

\* Denotes Standard Build

Stock Code	Description
1 ECO2506	Everyday Tip Adaptor M6
2 B2502	Shroud Spring
3 ECO2501	Everyday Swan Neck
4 B1515/PG	Handle Location Body
5 B1505	Lock Nut M10
6 ECO8020	Cable Spring Support
7 B1521	Cable Terminal-Female
8 ECO8514	Eco-Grip Max <sup>®</sup> Handle Kit
9 B8516	Eco-Grip Max <sup>®</sup> Trigger
10 B2503-30	Cable Assembly x 3m/10ft
B2503-40	Cable Assembly x 4m/13ft
B2503-50	Cable Assembly x 5m/16ft
11 B1522	Cable Terminal-Male
12 B1841	Cable Support
13 B1518	Gun Plug Housing c/w Nut
14 B1526	Gun Plug Screw
15 B1519	Gun Plug Nut c/w Insert
16 Spring Pin 2	Spring Pin Assembly
17 ECB1528	Gun Plug Body c/w Spring Pins
18 B1524	Gun Plug 'O' Ring
19 B1525	Liner Nut

# Eco-Grip Max® 360A

## Air Cooled MIG Torch

240A CO<sub>2</sub>, 216A Mixed Gas @ 60% Duty Cycle, EN60974-7 .030"- .045"/0.8mm to 1.2mm Wires

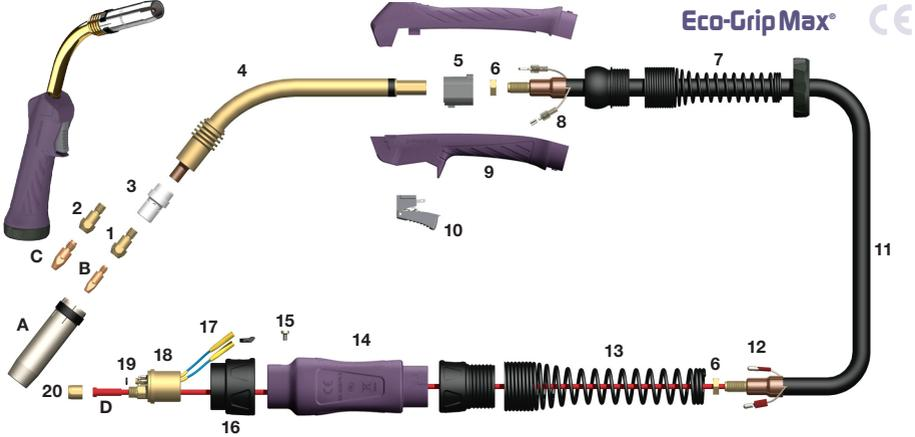

### Models

Stock Code	Description
ECR3600-30ER	Eco-Grip Max® Torch Package c/w Euro Fitting x 3m
ECR3600-40ER	Eco-Grip Max® Torch Package c/w Euro Fitting x 4m
ECR3600-50ER	Eco-Grip Max® Torch Package c/w Euro Fitting x 5m

### Nozzles

Stock Code	Description
A ECO3615	Everyday Cylindrical Nozzle 3/4"/19mm Bore
ECO3616*	Everyday Conical Nozzle 5/8"/16mm Bore
ECO3617	Everyday Tapered Nozzle 15/32"/12mm Bore

### Contact Tips

Stock Code	Description
B ECO2504-08	Everyday Contact Tip .030"/0.8mm M6 ECu
ECO2504-10	Everyday Contact Tip .040"/1.0mm M6 ECu
ECO2504-12*	Everyday Contact Tip .045"/1.2mm M6 ECu
ECO2505-08	Everyday Contact Tip .030"/0.8mm M6 CuCrZr
ECO2505-10	Everyday Contact Tip .040"/1.0mm M6 CuCrZr
ECO2505-12	Everyday Contact Tip .045"/1.2mm M6 CuCrZr
C ECO4014-10	Everyday Contact Tip .040"/1.0mm M8 ECu
ECO4014-12	Everyday Contact Tip .045"/1.2mm M8 ECu

### Liners

Stock Code	Description
D ECO1535-30	Everyday Steel Liner .023"-.035"/0.6-0.9mm x 3m
ECO1535-40	Everyday Steel Liner .023"-.035"/0.6-0.9mm x 4m
ECO1535-50	Everyday Steel Liner .023"-.035"/0.6-0.9mm x 5m
ECO2524-30*	Everyday Steel Liner .040"-.045"/1.0-1.2mm x 3m
ECO2524-40*	Everyday Steel Liner .040"-.045"/1.0-1.2mm x 4m
ECO2524-50	Everyday Steel Liner .040"-.045"/1.0-1.2mm x 5m

### Components

\* Denotes Standard Build

Stock Code	Description
1 ECO3612*	Everyday Tip Adaptor, 28.5mm M6
2 ECO3614	Everyday Tip Adaptor, 28.5mm M8
3 B3605B	Diffuser Black
B3605C	Diffuser Ceramic
B3605W	Diffuser White
4 ECO3603	Eco-Grip Max® Swan Neck
5 B1515/PG	Handle Location Body
6 B1505	Lock Nut
7 ECO8020	Cable Spring Support
8 B1521	Cable Terminal-Female
9 ECO8514	Eco-Grip Max® Handle Kit
10 B8516	Eco-Grip Max® Trigger
11 B3609-30	Cable Assembly x 3m/10ft
B3609-40	Cable Assembly x 4m/13ft
B3609-50	Cable Assembly x 5m/16ft
12 B1522	Cable Terminal-Male
13 B8026	Cable Support
14 B1518	Gun Plug Housing c/w Nut
15 B1526	Gun Plug Screw
16 B1519/BK	Gun Plug Nut-Black
17 B1519	Spring Pin Assembly
18 B1528	Gun Plug Body c/w Spring Pins
19 B1524	Gun Plug 'O' Ring
20 B1525	Liner Nut

# Eco-Grip Max® 401W

## Water Cooled MIG Welding Torch

400A CO<sub>2</sub>, 350A Mixed Gas @ 100% Duty Cycle, EN60974-7 .030"-.045"/0.8mm to 1.2mm Wires

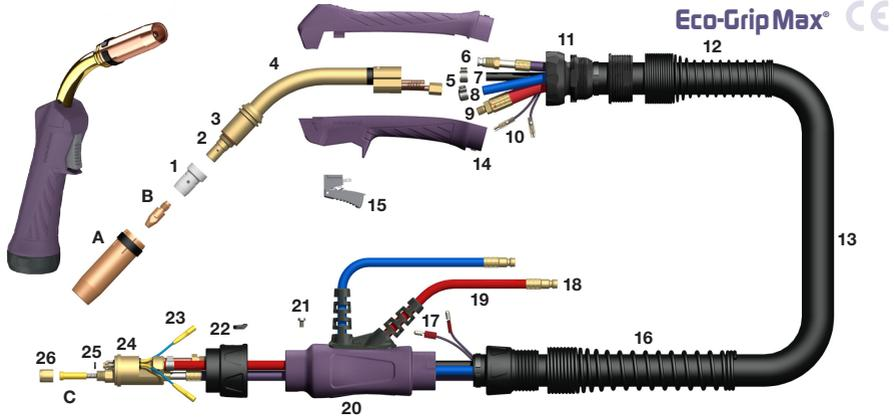

### Models

Stock Code	Description
ECR4001-30ER	Eco-Grip Max® Torch Package c/w Euro Fitting x 3m
ECR4001-40ER	Eco-Grip Max® Torch Package c/w Euro Fitting x 4m
ECR4001-50ER	Eco-Grip Max® Torch Package c/w Euro Fitting x 5m

### Nozzles

Stock Code	Description
A ECO5027	Cylindrical Nozzle 3/4"/19mm Bore
ECO5028*	Conical Nozzle 5/8"/16mm Bore
ECO5029	Tapered Nozzle 15/32"/12mm Bore

### Contact Tips

Stock Code	Description
B ECO4014-08	Contact Tip .030"/0.8mm M8 ECu
ECO4014-10	Contact Tip .040"/1.0mm M8 ECu
ECO4014-12*	Contact Tip .045"/1.2mm M8 ECu
ECO4015-10	Contact Tip .040"/1.0mm M8 CuCrZr
ECO4015-12	Contact Tip .045"/1.2mm M8 CuCrZr

### Liners

Stock Code	Description
C B5033-30*	Plain Liner .040"-.045"/1.0mm-1.2mm x 3m
B5033-40*	Plain Liner .040"-.045"/1.0mm-1.2mm x 4m
B5033-50*	Plain Liner .040"-.045"/1.0mm-1.2mm x 5m
B2513-30	Teflon Liner .040"-.045"/1.0mm-1.2mm x 3m
B2513-40	Teflon Liner .040"-.045"/1.0mm-1.2mm x 4m
B2513-50	Teflon Liner .040"-.045"/1.0mm-1.2mm x 5m

### Components

\* Denotes Standard Build

Stock Code	Description
1 B5005B	Diffuser Black
B5005C*	Diffuser Ceramic
B5005W	Diffuser White
2 B5001	Tip Adaptor 1"/25mm M8
3 B5003	Insulating Washer
4 ECO4011	Swan Neck
5 B5024	Water Hose Clamp 9.5mm
6 B5008-40	Outer Liner Assembly x 4m
B5008-50	Outer Liner Assembly x 5m
7 B5013-40	Gas Hose Assembly x 4m
B5013-50	Gas Hose Assembly x 5m
8 B5012-40 PVC	Water Inlet Hose Assembly x 4m
B5012-50 PVC	Water Inlet Hose Assembly x 5m
9 B5015-40 PVC	Power Cable Assembly x 4m
B5015-50 PVC	Power Cable Assembly x 5m
10 B5010-40	Switch Lead Assembly x 4m
B5010-50	Switch Lead Assembly x 5m
11 B8031	Ball Joint Assembly c/w Clamp
12 B8032	Spring Cable Support c/w Adaptor
13 B5019-40	Canvas Cover Assembly x 4m
B5019-50	Canvas Cover Assembly x 5m
14 B7594	Eco-Grip Max® Handle Kit
15 B2516	Eco-Grip Max® Trigger
16 B8027	Spring Cable Support-Rear
17 B1522	Cable Terminal-Male
18 B5023	Water Hose Nipple
19 B5017	Water Outlet Hose O/Braid
20 B5022	Gun Plug Housing c/w Lock Nut and Hose Supports
21 B1526	Gun Plug Screw
22 B1519	Gun Plug Nut c/w Insert
23 Spring Pin 2	Spring Pin Assembly
24 B5098	Gun Plug Body c/w Spring Pins
25 B1524	Gun Plug 'O' Ring
26 B1525	Liner Nut

# Eco-Grip Max® 501W

## Water Cooled MIG Welding Torch

400A CO<sub>2</sub>, 360A Mixed Gas @ 100% Duty Cycle, EN60974-7 .040"-1/16"/1.0mm to 1.6mm Wires

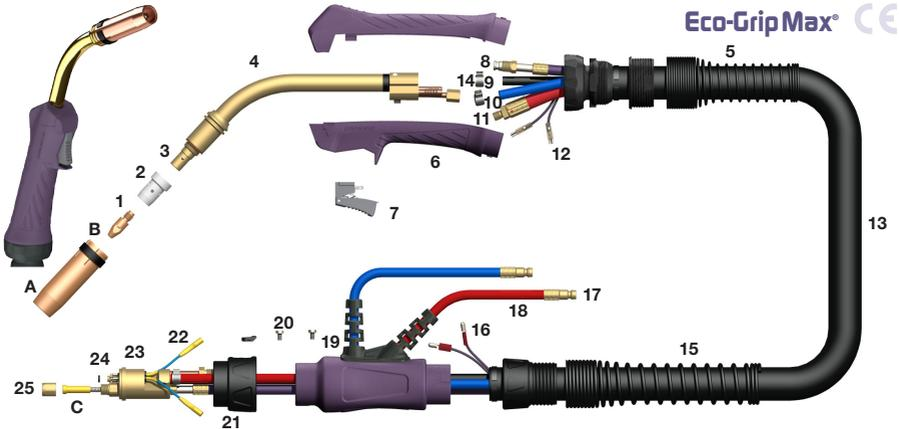

### Models

Stock Code	Description
ECR5000-30ER	Eco-Grip Max® Torch Package c/w Euro Fitting x 3m
ECR5000-40ER	Eco-Grip Max® Torch Package c/w Euro Fitting x 4m
ECR5000-50ER	Eco-Grip Max® Torch Package c/w Euro Fitting x 5m

### Nozzles

Stock Code	Description
A ECO5027	Everyday Cylindrical Nozzle 3/4"/19mm Bore
ECO5028*	Everyday Conical Nozzle 5/8"/16mm Bore
ECO5029	Everyday Tapered Nozzle 9/16"/14mm Bore

### Contact Tips

Stock Code	Description
B ECO4014-10	Everyday Contact Tip .040"/1.0mm M8 ECu
ECO4014-12	Everyday Contact Tip .045"/1.2mm M8 ECu
ECO4014-16	Everyday Contact Tip 1/16"/1.6mm M8 ECu
B4015-10	Contact Tip .040"/1.0mm M8 CuCrZr
B4015-12*	Contact Tip .045"/1.2mm M8 CuCrZr
B4015-16	Contact Tip 1/16"/1.6mm M8 CuCrZr

### Liners

Stock Code	Description
C B5033-30	Plain Liner .040"-.045"/1.0-1.2mm x 3m
B5033-40	Plain Liner .040"-.045"/1.0-1.2mm x 4m
B5034-30*	Plain Liner .045"-1/16"/1.2-1.6mm x 3m
B5034-40*	Plain Liner .045"-1/16"/1.2-1.6mm x 4m
B4033-30	Plain Liner .080"-.090"/2.0-2.4mm x 3m
B4033-40	Plain Liner .080"-.090"/2.0-2.4mm x 4m
B2513-30	Teflon Liner .040"-.045"/1.0-1.2mm x 3m
B2513-40	Teflon Liner .040"-.045"/1.0-1.2mm x 4m
B3626-30	Teflon Liner .045"-1/16"/1.2mm-1.6mm x 3m
B3626-40	Teflon Liner .045"-1/16"/1.2mm-1.6mm x 4m

### Components

\* Denotes Standard Build

Stock Code	Description
1 B5005B	Diffuser Black
B5005C	Diffuser Ceramic
B5005W*	Diffuser White
2 ECO5001	Tip Adaptor, 25.0mm M8
3 B5003	Insulating Washer
4 ECO5002	Everyday Swan Neck
5 ECO8032	Cable Spring Support
6 ECO8514	Eco-Grip Max® Handle Kit
7 B8516	Eco-Grip Max® Trigger
8 B5008-30	Outer Liner Assembly x 3m
B5008-40	Outer Liner Assembly x 4m
9 B5013-30	Gas Hose Assembly, PVC x 3m
B5013-40	Gas Hose Assembly, PVC x 4m
10 B5012-30 PVC	Water Inlet Hose Assembly x 3m
B5012-40 PVC	Water Inlet Hose Assembly x 4m
11 B5015-30 PVC	Gas Hose Assembly, PVC x 3m
B5015-40 PVC	Gas Hose Assembly, PVC x 4m
12 B5010-30	Switch Lead Assembly x 3m
B5010-40	Switch Lead Assembly x 4m
13 B5019-30	Canvas Cover Assembly x 3m
B5019-40	Canvas Cover Assembly x 4m
14 B5024	Water Hose Clamp, 9.5mm
15 B8027	Cable Spring Support
16 B1522	Cable Terminal-Male
17 B5023	Water Hose Nipple
18 B5017 PVC	Water Outlet Hose
19 B5022/BK	Gun Plug Housing c/w Lock Nut and Hose Supports
20 B1526	Gun Plug Screw
21 B1519/BK	Gun Plug Nut
22 B1523	Gun Plug Terminal
23 B5098	Gun Plug Body c/w Spring Pins
24 B1524	Gun Plug 'O' Ring
25 B1525	Liner Nut

# SB 120A

## Air Cooled MIG Torch

140A CO<sub>2</sub>, 120A Mixed Gas @ 60% Duty Cycle, EN60974-7 .023"-.035"/0.6mm to 0.8mm Wires

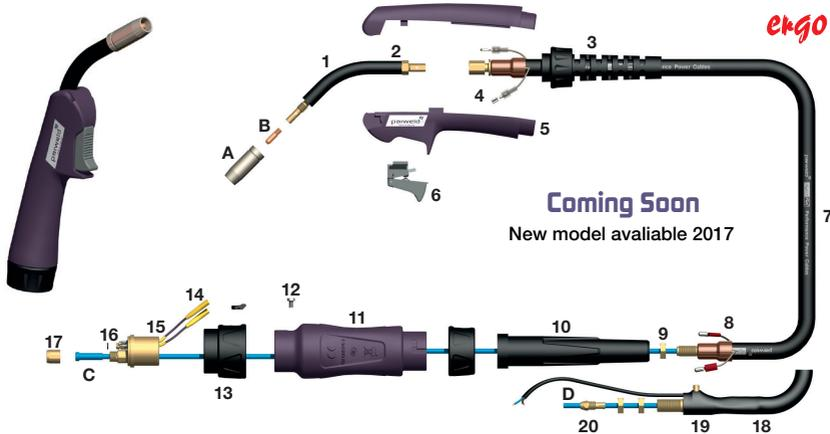

Models	
Stock Code	Description
B1200-30ER	Welding Torch Package c/w Euro Fitting x 3m
B1200-40ER	Welding Torch Package c/w Euro Fitting x 4m
B1200-30TEL	Welding Torch Package c/w Telwin Fitting 3m

Nozzles	
Stock Code	Description
A B1430*	Conical Nozzle Screw On 7/16"/11mm Bore
B1431	Spot Welding Nozzle Screw On 1/2"/13mm Bore

Contact Tips	
Stock Code	Description
B B1427-06	Contact Tip .023"/0.6mm M5 ECU
B1427-08	Contact Tip .030"/0.8mm M5 ECU

Linners	
Stock Code	Description
C B1435-30*	Steel Linner .023"-.030"/0.6-0.8mm x 3m
B1435-40*	Steel Linner .023"-.030"/0.6-0.8mm x 4m
B1436-30	Nylon Linner .023"-.030"/0.6-0.8mm x 3m
B1436-40	Nylon Linner .023"-.030"/0.6-0.8mm x 4m
D B1435-30TEL	Steel Linner .023"-.030"/0.6-0.8mm x 3m Telwin
B1435-40TEL	Steel Linner .023"-.030"/0.6-0.8mm x 4m Telwin

Components		* Denotes Standard Build
Stock Code	Description	
1 B1401	Swan Neck-Screw On Nozzle	
NI B1401-P	Swan Neck-Push On Nozzle	
2 B1402	Insulation Sleeve	
3 B8011	Eco-Grip® Cable Support	
4 B1521	Cable Terminal	
5 B1414	Eco-Grip® Handle Kit c/w Lock Nut and Trigger	
6 B1416	Eco-Grip® Trigger	
7 B1317-30	Hyperflex™ Cable Assembly x 3m	
B1317-40	Hyperflex™ Cable Assembly x 4m	
8 B1522	Cable Terminal-Male	
9 B1505	Lock Nut	
10 B1841	Cable Support	
11 B1518	Gun Plug Housing c/w Nut	
12 B1526	Gun Plug Screw	
13 B1519PL	Gun Plug Nut-Plastic c/w Insert	
14 Spring Pin 2	Spring Pin Assembly	
15 B1528	Gun Plug Body c/w Spring Pins	
16 B1524	Gun Plug 'O' Ring	
17 B1525	Linner Nut	
18 B1251	Strain Relief	
19 B1217-30TEL	Hyperflex™ Cable Assembly x 3m Telwin	
20 B1552	Telwin Linner Collet	

## SB 140A

## Air Cooled MIG Torch

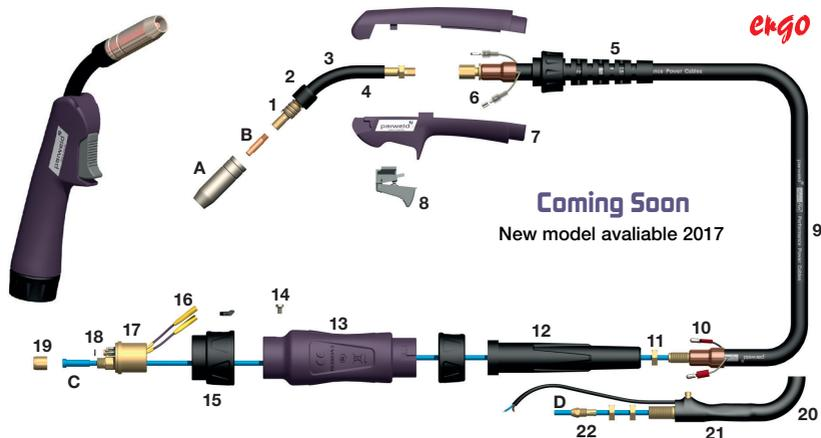
160A CO<sub>2</sub>, 140A Mixed Gas @ 60% Duty Cycle, EN60974-7 .023"-.035"/0.6mm to 0.9mm Wires

Coming Soon  
New model available 2017

## Models

Stock Code	Description
B1400-30ER	Welding Torch Package c/w Euro Fitting x 3m
B1400-40ER	Welding Torch Package c/w Euro Fitting x 4m
B1400-30TEL	Welding Torch Package c/w Telwin Fitting x 3m

## Nozzles

Stock Code	Description
A B1529	Cylindrical Nozzle 5/8"/16mm Bore
B1530*	Conical Nozzle 15/32"/12mm Bore
B1531	Tapered Nozzle 7/16"/11mm Bore
B1532	Bottle Nozzle 1/2"/13mm Bore
B1533	Spot Welding Nozzle 5/8"/16mm Bore

## Contact Tips

Stock Code	Description
B B1527-06	Contact Tip .023"/0.6mm M6 ECu
B1527-08*	Contact Tip .030"/0.8mm M6 ECu
B1527-09	Contact Tip .035"/0.9mm M6 ECu

## Liners

Stock Code	Description
C B1535-30*	Steel Liner .023"-.035"/0.6mm-0.9mm x 3m
B1535-40*	Steel Liner .023"-.035"/0.6mm-0.9mm x 4m
B1536-30	Teflon Liner .023"-.035"/0.6mm-0.9mm x 3m
B1536-40	Teflon Liner .023"-.035"/0.6mm-0.9mm x 4m
D B1535-30TEL	Steel Liner .023"-.035"/0.6-0.9mm x 3m Telwin
B1535-40TEL	Steel Liner .023"-.035"/0.6-0.9mm x 4m Telwin

## Components

\* Denotes Standard Build

Stock Code	Description
1 B1504	Shroud Spring
2 B1503	Insulator
3 B1502	Insulation Sleeve
4 B1415	Swan Neck
5 B8011	Eco-Grip® Cable Support
6 B1521	Cable Terminal
7 B1414	Ergo Handle Kit c/w Lock Nut and Trigger
8 B1416	Ergo Trigger
9 B1417-30	Hyperflex™ Cable Assembly x 3m
B1417-40	Hyperflex™ Cable Assembly x 4m
10 B1522	Cable Terminal-Male
11 B1505	Lock Nut
12 B1841	Cable Support
13 B1518	Gun Plug Housing c/w Nut
14 B1526	Gun Plug Screw
15 B1519PL	Gun Plug Nut-Plastic c/w Insert
16 Spring Pin 2	Spring Pin Assembly
17 B1528	Gun Plug Body c/w Spring Pins
18 B1524	Gun Plug 'O' Ring
19 B1525	Liner Nut
20 B1251	Strain Relief
21 B1217-30TEL	Hyperflex™ Cable Assembly x 3m Telwin
22 B1552	Telwin Liner Collet

# Pro-Grip Max<sup>®</sup> 150A

## Air Cooled MIG Torch

180A CO<sub>2</sub>, 150A Mixed Gas @ 60% Duty Cycle, EN60974-7 .023"- .040"/0.6mm to 1.0mm Wires

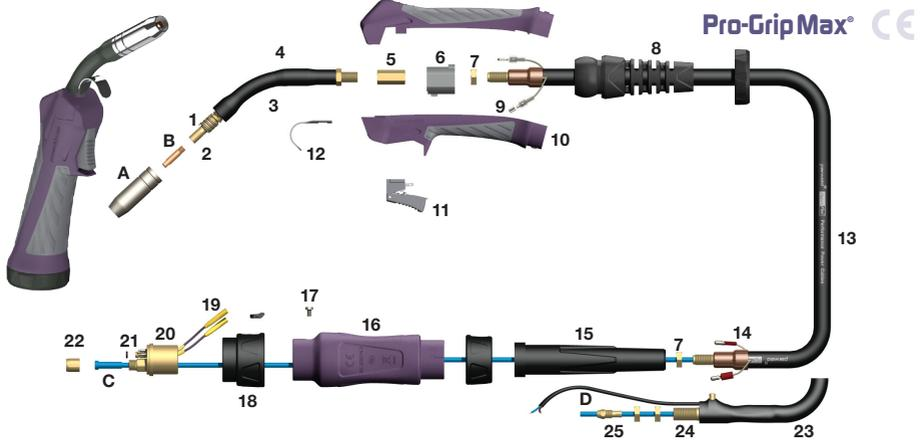

### Models

Stock Code	Description
PRO1500-30ER	Pro-Grip Max <sup>®</sup> Welding Torch c/w Euro Fitting x 3m
PRO1500-40ER	Pro-Grip Max <sup>®</sup> Welding Torch c/w Euro Fitting x 4m
PRO1500-50ER	Pro-Grip Max <sup>®</sup> Welding Torch c/w Euro Fitting x 5m
PRO1500-30TEL	Pro-Grip Max <sup>®</sup> Welding Torch c/w Telwin Fitting x 3m
PRO1500-40TEL	Pro-Grip Max <sup>®</sup> Welding Torch c/w Telwin Fitting x 4m
PRO1500-50TEL	Pro-Grip Max <sup>®</sup> Welding Torch c/w Telwin Fitting x 5m

### Nozzles

Stock Code	Description
A B1529	Cylindrical Nozzle 5/8"/16mm Bore
B1530*	Conical Nozzle 15/32"/12mm Bore
B1531	Tapered Nozzle 7/16"/11mm Bore
B1532	Bottle Nozzle 1/2"/13mm Bore
B1533	Spot Welding Nozzle 5/8"/16mm Bore

### Contact Tips

Stock Code	Description
B B1527-06	Contact Tip .023"/0.6mm M6 ECU
B1527-08*	Contact Tip .030"/0.8mm M6 ECU
B1527-09	Contact Tip .035"/0.9mm M6 ECU
B1527-10	Contact Tip .040"/1.0mm M6 ECU

### Liners

Stock Code	Description
C B1535-30*	Steel Liner .023"- .035"/0.6mm-0.9mm x 3m
B1535-40*	Steel Liner .023"- .035"/0.6mm-0.9mm x 4m
B1535-50*	Steel Liner .023"- .035"/0.6mm-0.9mm x 5m
B1536-30	Teflon Liner .023"- .035"/0.6mm-0.9mm x 3m
B1536-40	Teflon Liner .023"- .035"/0.6mm-0.9mm x 4m
B1536-50	Teflon Liner .023"- .035"/0.6mm-0.9mm x 5m
D B1535-40TEL	Steel Liner .023"- .035"/0.6mm-0.9mm x 4m Telwin
B1535-50TEL	Steel Liner .023"- .035"/0.6mm-0.9mm x 5m Telwin

### Components

\* Denotes Standard Build

Stock Code	Description
1 B1504	Shroud Spring
2 B1507 L/H	Tip Adaptor
3 B1501	Swan Neck c/w Tip Adaptor, Spring and Sleeve
4 B1502	Insulation Sleeve
5 B2519	Hexagonal Fitting
6 B1515/PG	Handle Location Body
7 B1505	Lock Nut
8 B8015	Cable Support c/w Knuckle Joint
9 B1521	Cable Terminal
10 B8514	Pro-Grip Max <sup>®</sup> Handle Kit
11 B8516	Pro-Grip Max <sup>®</sup> Trigger
12 B2517	Hanger Hook
13 B1517-30	Hyperflex <sup>™</sup> Cable Assembly x 3m
B1517-40	Hyperflex <sup>™</sup> Cable Assembly x 4m
B1517-50	Hyperflex <sup>™</sup> Cable Assembly x 5m
14 B1522	Cable Terminal-Male
15 B1841	Cable Support c/w Knuckle Joint
16 B1518	Gun Plug Housing c/w Nut
17 B1526	Gun Plug Screw
18 B1519PL	Gun Plug Nut-Plastic c/w Insert
19 Spring Pin 2	Spring Pin Assembly
20 B1528	Gun Plug Body c/w Spring Pins
21 B1524	Gun Plug 'O' Ring
22 B1525	Liner Nut
23 B1251	Strain Relief
24 B1517-30TEL	Hyperflex <sup>™</sup> Cable Assembly x 3m Telwin
B1517-40TEL	Hyperflex <sup>™</sup> Cable Assembly x 4m Telwin
B1517-50TEL	Hyperflex <sup>™</sup> Cable Assembly x 5m Telwin
25 B1552	Liner Collet

# Pro-Grip Max® 150A Flex

## Air Cooled MIG Torch

180A CO<sub>2</sub>, 150A Mixed Gas @ 60% Duty Cycle, EN60974-7 .023"-.040"/0.6mm to 1.0mm Wires

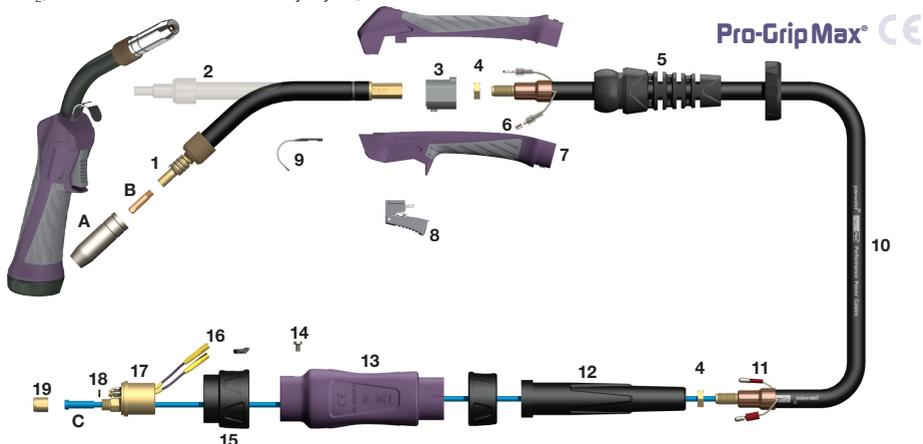

### Models

Stock Code	Description
PRO1500FX-30ER	Pro-Grip Max® Flex Welding Torch c/w Euro Fitting x 3m
PRO1500FX-40ER	Pro-Grip Max® Flex Welding Torch c/w Euro Fitting x 4m

### Nozzles

Stock Code	Description
A B1529	Cylindrical Nozzle 5/8"/16mm Bore
B1530*	Conical Nozzle 15/32"/12mm Bore
B1531	Tapered Nozzle 7/16"/11mm Bore
B1532	Bottle Nozzle 1/2"/13mm Bore
B1533	Spot Welding Nozzle 5/8"/16mm Bore

### Contact Tips

Stock Code	Description
B B1527-06	Contact Tip .023"/0.6mm M6 ECU
B1527-08*	Contact Tip .030"/0.8mm M6 ECU
B1527-09	Contact Tip .035"/0.9mm M6 ECU
B1527-10	Contact Tip .040"/1.0mm M6 ECU

### Liners

Stock Code	Description
C B1535-30*	Steel Liner .023"-.035"/0.6mm-0.9mm x 3m
B1535-40*	Steel Liner .023"-.035"/0.6mm-0.9mm x 4m
B1536-30	Teflon Liner .023"-.035"/0.6mm-0.9mm x 3m
B1536-40	Teflon Liner .023"-.035"/0.6mm-0.9mm x 4m

### Components

\* Denotes Standard Build

Stock Code	Description
1 B1504	Shroud Spring
2 B1501FX	Swan Neck
3 B1515/PG	Handle Location Body
4 B1505	Lock Nut
5 B8015	Cable Support c/w Knuckle Joint
6 B1521	Cable Terminal
7 B8514	Pro-Grip Max® Handle Kit
8 B8516	Pro-Grip Max® Trigger
9 B2517	Hanger Hook
10 B1517-30	Hyperflex™ Cable Assembly x 3m
B1517-40	Hyperflex™ Cable Assembly x 4m
11 B1522	Cable Terminal-Male
12 B1841	Cable Support
13 B1518	Gun Plug Housing c/w Nut
14 B1526	Gun Plug Screw
15 B1519PL	Gun Plug Nut-Plastic c/w Insert
16 B1528	Spring Pin Assembly
17 B1528	Gun Plug Body c/w Spring Pins
18 B1524	Gun Plug 'O' Ring
19 B1525	Liner Nut

# Pro-Grip Max® 240A

## Air Cooled MIG Torch

250A CO<sub>2</sub>, 220A Mixed Gas @ 60% Duty Cycle, EN60974-7 .030"- .045"/0.8mm to 1.2mm Wires

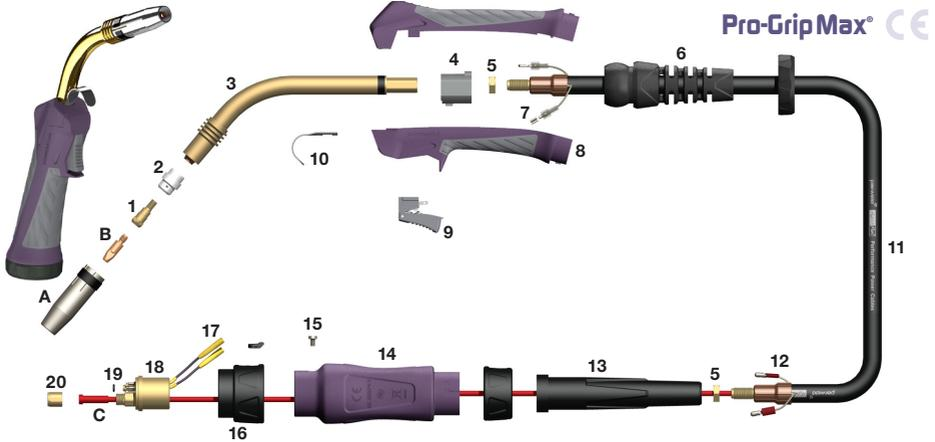

Models	
Stock Code	Description
PRO2400-30ER	Pro-Grip Max® Welding Torch c/w Euro Fitting x 3m
PRO2400-40ER	Pro-Grip Max® Welding Torch c/w Euro Fitting x 4m
PRO2400-50ER	Pro-Grip Max® Welding Torch c/w Euro Fitting x 5m

Nozzles	
Stock Code	Description
A B2415	Cylindrical Nozzle 11/16"/17mm Bore
B2416*	Conical Nozzle 1/2"/13mm Bore
B2417	Tapered Nozzle 3/8"/10mm Bore

Contact Tips	
Stock Code	Description
B B2504-08	Contact Tip .030"/0.8mm M6 ECU
B2504-10*	Contact Tip .040"/1.0mm M6 ECU
B2504-12	Contact Tip .045"/1.2mm M6 ECU
B2505-08	Contact Tip .030"/0.8mm M6 CuCrZr
B2505-10	Contact Tip .040"/1.0mm M6 CuCrZr
B2505-12	Contact Tip .045"/1.2mm M6 CuCrZr

Linners	
Stock Code	Description
C B1535-30	Steel Linner .023"- .035"/0.6mm-0.9mm x 3m
B1535-40	Steel Linner .023"- .035"/0.6mm-0.9mm x 4m
B1535-50	Steel Linner .023"- .035"/0.6mm-0.9mm x 5m
B2524-30*	Steel Linner .040"- .045"/1.0mm-1.2mm x 3m
B2524-40*	Steel Linner .040"- .045"/1.0mm-1.2mm x 4m
B2524-50*	Steel Linner .040"- .045"/1.0mm-1.2mm x 5m
B1536-30	Teflon Linner .023"- .035"/0.6mm-0.9mm x 3m
B1536-40	Teflon Linner .023"- .035"/0.6mm-0.9mm x 4m
B1536-50	Teflon Linner .023"- .035"/0.6mm-0.9mm x 5m
B2513-30	Teflon Linner .040"- .045"/1.0mm-1.2mm x 3m
B2513-40	Teflon Linner .040"- .045"/1.0mm-1.2mm x 4m
B2513-50	Teflon Linner .040"- .045"/1.0mm-1.2mm x 5m

Components		* Denotes Standard Build
Stock Code	Description	
1 B2412	Tip Adaptor M6	
2 B2405B	Diffuser Black	
B2405C*	Diffuser Ceramic	
B2405W	Diffuser White	
3 B2401	Swan Neck	
4 B1515/PG	Handle Location Body	
5 B1505	Lock Nut	
6 B8015	Cable Support c/w Knuckle Joint	
7 B1521	Cable Terminal	
8 B8514	Pro-Grip Max® Handle Kit	
9 B8516	Pro-Grip Max® Trigger	
10 B2517	Hanger Hook	
11 B2603-30	Hyperflex™ Cable Assembly x 3m	
B2603-40	Hyperflex™ Cable Assembly x 4m	
B2603-50	Hyperflex™ Cable Assembly x 5m	
12 B1522	Cable Terminal-Male	
13 B2841	Cable Support	
14 B1518	Gun Plug Housing c/w Nut	
15 B1526	Gun Plug Screw	
16 B1519	Gun Plug Nut c/w Insert	
17 Spring Pin 2	Spring Pin Assembly	
18 B1528	Gun Plug Body c/w Spring Pins	
19 B1524	Gun Plug 'O' Ring	
20 B1525	Liner Nut	

# Pro-Grip Max<sup>®</sup> 250A

## Air Cooled MIG Torch

230A CO<sub>2</sub>, 200A Mixed Gas @ 60% Duty Cycle, EN60974-7 .030"- .045"/0.8mm to 1.2mm Wires

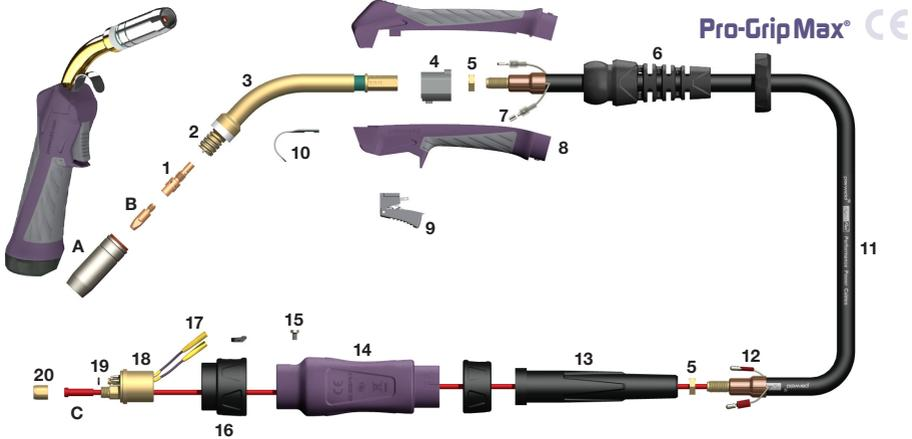

### Models

Stock Code	Description
PRO2500-30ER	Pro-Grip Max <sup>®</sup> Welding Torch c/w Euro Fitting x 3m
PRO2500-40ER	Pro-Grip Max <sup>®</sup> Welding Torch c/w Euro Fitting x 4m
PRO2500-50ER	Pro-Grip Max <sup>®</sup> Welding Torch c/w Euro Fitting x 5m

### Nozzles

Stock Code	Description
A B2507	Cylindrical Nozzle 5/7"/18mm Bore
B2508*	Conical Nozzle 19/32"/15mm Bore
B2509	Tapered Nozzle 15/32"/12mm Bore
B2510	Bottle Nozzle 19/32"/15mm Bore
B2511	Spot Welding Nozzle 5/7"/18mm Bore

### Contact Tips

Stock Code	Description
B B2504-08	Contact Tip .030"/0.8mm M6 Ecu
B2504-09	Contact Tip .035"/0.9mm M6 Ecu
B2504-10*	Contact Tip .040"/1.0mm M6 Ecu
B2504-12	Contact Tip .045"/1.2mm M6 Ecu
B2505-08	Contact Tip .030"/0.8mm CuCrZr
B2505-09	Contact Tip .035"/0.9mm CuCrZr
B2505-10	Contact Tip .040"/1.0mm CuCrZr
B2505-12	Contact Tip .045"/1.2mm CuCrZr

### Liners

Stock Code	Description
C B1535-30	Steel Liner .023"- .035"/0.6mm-0.9mm x 3m
B1535-40	Steel Liner .023"- .035"/0.6mm-0.9mm x 4m
B1535-50	Steel Liner .023"- .035"/0.6mm-0.9mm x 5m
B2524-30*	Steel Liner .040"- .045"/1.0mm-1.2mm x 3m
B2524-40*	Steel Liner .040"- .045"/1.0mm-1.2mm x 4m
B2524-50*	Steel Liner .040"- .045"/1.0mm-1.2mm x 5m
B1536-30	Teflon Liner .023"- .035"/0.6mm-0.9mm x 3m
B1536-40	Teflon Liner .023"- .035"/0.6mm-0.9mm x 4m

### Liners

\* Denotes Standard Build

Stock Code	Description
B1536-50	Teflon Liner .023"- .035"/0.6mm-0.9mm x 5m
B2513-30	Teflon Liner .040"- .045"/1.0mm-1.2mm x 3m
B2513-40	Teflon Liner .040"- .045"/1.0mm-1.2mm x 4m
B2513-50	Teflon Liner .040"- .045"/1.0mm-1.2mm x 5m

### Components

Stock Code	Description
1 B2506*	Tip Adaptor M6
NI B2536	Tip Adaptor M8 (See M8 Tips)
2 B2502	Shroud Spring
3 B2501	Swan Neck
4 B1515/PG	Handle Location Body
5 B1505	Lock Nut
6 B8015	Cable Support c/w Knuckle Joint
7 B1521	Cable Terminal
8 B8514	Pro-Grip Max <sup>®</sup> Handle Kit
9 B8516	Pro-Grip Max <sup>®</sup> Trigger
10 B2517	Hanger Hook
11 B2503-30	Hyperflex™ Cable Assembly x 3m
B2503-40	Hyperflex™ Cable Assembly x 4m
B2503-50	Hyperflex™ Cable Assembly x 5m
12 B1522	Cable Terminal-Male
13 B2841	Cable Support
14 B1518	Gun Plug Housing c/w Nut
15 B1526	Gun Plug Screw
16 B1519	Gun Plug Nut c/w Insert
17 Spring Pin 2	Spring Pin Assembly
18 B1528	Gun Plug Body c/w Spring Pins
19 B1524	Gun Plug 'O' Ring
20 B1525	Liner Nut

# Pro-Grip Max® 250A Flex

## Air Cooled MIG Torch

230A CO<sub>2</sub>, 200A Mixed Gas @ 60% Duty Cycle, EN60974-7 .030"- .045"/0.8mm to 1.2mm Wires

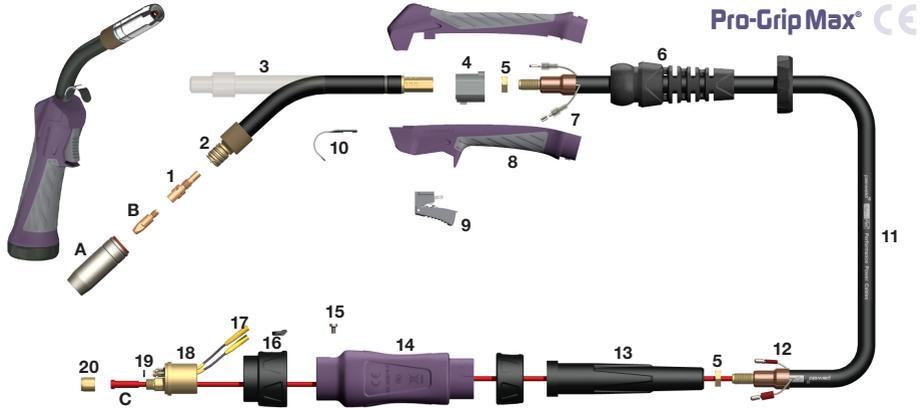

### Models

Stock Code	Description
PRO2500FX-30ER	Pro-Grip Max® Flex Welding Torch c/w Euro Fitting x 3m
PRO2500FX-40ER	Pro-Grip Max® Flex Welding Torch c/w Euro Fitting x 4m

### Nozzles

Stock Code	Description
A B2507	Cylindrical Nozzle 5/7" / 18mm Bore
B2508*	Conical Nozzle 19/32" / 15mm Bore
B2509	Tapered Nozzle 15/32" / 12mm Bore
B2510	Bottle Nozzle 19/32" / 15mm Bore
B2511	Spot Welding Nozzle 19/32" / 15mm Bore

### Contact Tips

Stock Code	Description
B B2504-08	Contact Tip .030" / 0.8mm M6 ECu
B2504-10*	Contact Tip .040" / 1.0mm M6 ECu
B2504-12	Contact Tip .045" / 1.2mm M6 ECu
B2505-08	Contact Tip .030" / 0.8mm M6 CuCrZr
B2505-10	Contact Tip .040" / 1.0mm M6 CuCrZr
B2505-12	Contact Tip .045" / 1.2mm M6 CuCrZr

### Liners

Stock Code	Description
C B1535-30	Steel Liner .023"-.035" / 0.6mm-0.9mm x 3m
B1535-40	Steel Liner .023"-.035" / 0.6mm-0.9mm x 4m
B2524-30*	Steel Liner .040"-.045" / 1.0mm-1.2mm x 3m
B2524-40*	Steel Liner .040"-.045" / 1.0mm-1.2mm x 4m
B1536-30	Teflon Liner .023"-.035" / 0.6mm-0.9mm x 3m
B1536-40	Teflon Liner .023"-.035" / 0.6mm-0.9mm x 4m
B2513-30	Teflon Liner .040"-.045" / 1.0mm-1.2mm x 3m
B2513-40	Teflon Liner .040"-.045" / 1.0mm-1.2mm x 4m

### Components

\* Denotes Standard Build

Stock Code	Description
B2506*	Tip Adaptor M6
NI B2536	Tip Adaptor M8 (See M8 Tips)
2 B2502	Shroud Spring
3 B2501FX	Swan Neck
4 B1515/PG	Handle Location Body
5 B1505	Lock Nut
6 B8015	Cable Support c/w Knuckle Joint
7 B1521	Cable Terminal
8 B8514	Pro-Grip Max® Handle Kit
9 B8516	Pro-Grip Max® Trigger
10 B2517	Hanger Hook
11 B2503-30	Hyperflex™ Cable Assembly x 3m
B2503-40	Hyperflex™ Cable Assembly x 4m
12 B1522	Cable Terminal-Male
13 B2841	Cable Support
14 B1518	Gun Plug Housing c/w Nut
15 B1526	Gun Plug Screw
16 B1519	Gun Plug Nut c/w Insert
17 Spring Pin 2	Spring Pin Assembly
18 B1528	Gun Plug Body c/w Spring Pins
19 B1524	Gun Plug 'O' Ring
20 B1525	Liner Nut

# Pro-Grip Max® 260A

## Air Cooled MIG Torch

250A CO<sub>2</sub>, 220A Mixed Gas @ 60% Duty Cycle, EN60974-7 .030"- .045"/0.8mm to 1.2mm Wires

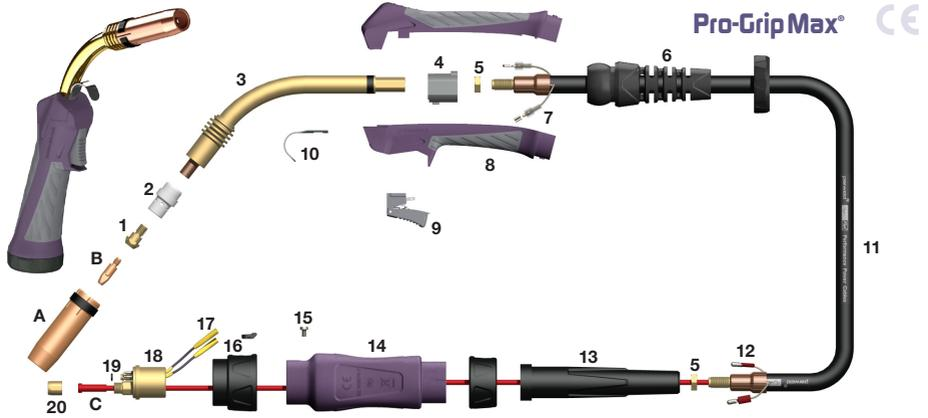

### Models

Stock Code	Description
PRO2600-30ER	Pro-Grip Max® Welding Torch c/w Euro Fitting x 3m
PRO2600-40ER	Pro-Grip Max® Welding Torch c/w Euro Fitting x 4m
PRO2600-50ER	Pro-Grip Max® Welding Torch c/w Euro Fitting x 5m

### Nozzles

Stock Code	Description
A B5027	Cylindrical Nozzle 3/4"/19mm Bore
B5028*	Conical Nozzle 5/8"/16mm Bore
B5029	Tapered Nozzle 9/16"/14mm Bore

### Contact Tips

Stock Code	Description
B 2504-08	Contact Tip .030"/0.8mm M6 ECU
B2504-09	Contact Tip .035"/0.9mm M6 ECU
B2504-10	Contact Tip .040"/1.0mm M6 ECU
B2504-12*	Contact Tip .045"/1.2mm M6 ECU
B2505-08	Contact Tip .030"/0.8mm M6 CuCrZr
B2505-09	Contact Tip .035"/0.9mm M6 CuCrZr
B2505-10	Contact Tip .040"/1.0mm M6 CuCrZr
B2505-12	Contact Tip .045"/1.2mm M6 CuCrZr

### Liners

Stock Code	Description
C B2524-30*	Steel Liner .040"- .045"/1.0mm-1.2mm x 3m
B2524-40*	Steel Liner .040"- .045"/1.0mm-1.2mm x 4m
B2524-50*	Steel Liner .040"- .045"/1.0mm-1.2mm x 5m
B2513-30	Teflon Liner .040"- .045"/1.0mm-1.2mm x 3m
B2513-40	Teflon Liner .040"- .045"/1.0mm-1.2mm x 4m
B2513-50	Teflon Liner .040"- .045"/1.0mm-1.2mm x 5m

### Components

\* Denotes Standard Build

Stock Code	Description
1 B2612	Tip Adaptor M6
NI B2312MB	Tip Adaptor M8
2 B2605B	Diffuser Black
B2605C*	Diffuser Ceramic
B2605W	Diffuser White
3 B2601	Swan Neck
4 B1515/PG	Handle Location Body
5 B1505	Lock Nut
6 B8015	Cable Support c/w Knuckle Joint
7 B1521	Cable Terminal
8 B8514	Pro-Grip Max® Handle Kit
9 B8516	Pro-Grip Max® Trigger
10 B2517	Hanger Hook
11 B2603-30	Hyperflex™ Cable Assembly x 3m
B2603-40	Hyperflex™ Cable Assembly x 4m
B2603-50	Hyperflex™ Cable Assembly x 5m
12 B1522	Cable Terminal-Male
13 B2841	Cable Support
14 B1518	Gun Plug Housing c/w Nut
15 B1526	Gun Plug Screw
16 B1519	Gun Plug Nut c/w Insert
17 Spring Pin 2	Spring Pin Assembly
18 B1528	Gun Plug Body c/w Spring Pins
19 B1524	Gun Plug 'O' Ring
20 B1525	Liner Nut

# Pro-Grip Max® 360A

## Air Cooled MIG Torch

300A CO<sub>2</sub>, 270A Mixed Gas @ 60% Duty Cycle, EN60974-7 .030"- .045"/0.8mm to 1.2mm Wires

Pro-Grip Max® CE

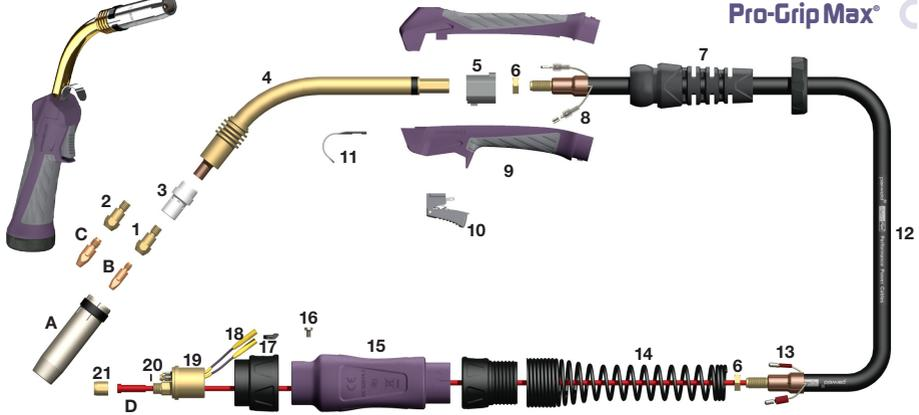

Models		Components	
Stock Code	Description	Stock Code	Description
PRO3600-30ER	Pro-Grip Max® Welding Torch c/w Euro Fitting x 3m	1 B3612*	Tip Adaptor 1.12"/28.5mm M6
PRO3600-40ER	Pro-Grip Max® Welding Torch c/w Euro Fitting x 4m	2 B3614	Tip Adaptor 1.12"/28.5mm M8
PRO3600-50ER	Pro-Grip Max® Welding Torch c/w Euro Fitting x 5m	NI B3613	Tip Adaptor 1.24"/31.5mm M6
		3 B3605B	Diffuser Black
		3 B3605C*	Diffuser Ceramic
		3 B3605W	Diffuser White
		4 B3603	Swan Neck
		5 B1515/PG	Handle Location Body
		6 B1505	Lock Nut
		7 B8016	Cable Support c/w Knuckle Joint
		8 B1521	Cable Terminal
		9 B8514	Pro-Grip Max® Handle Kit
		10 B8516	Pro-Grip Max® Trigger
		11 B2517	Hanger Hook
		12 B3609-30	Hyperflex™ Cable Assembly x 3m
		3 B3609-40	Hyperflex™ Cable Assembly x 4m
		3 B3609-50	Hyperflex™ Cable Assembly x 5m
		13 B1522	Cable Terminal-Male
		14 B8026	Spring Cable Support-Rear
		15 B1518	Gun Plug Housing c/w Nut
		16 B1526	Gun Plug Screw
		17 B1519	Gun Plug Nut c/w Insert
		18 Spring Pin 2	Spring Pin Assembly
		19 B1528	Gun Plug Body c/w Spring Pins
		20 B1524	Gun Plug 'O' Ring
		21 B1525	Liner Nut

\* Denotes Standard Build

### Nozzles

Stock Code	Description
A B3615	Cylindrical Nozzle 3/4"/19mm Bore
B3616*	Conical Nozzle 5/8"/16mm Bore
B3617	Tapered Nozzle 15/32"/12mm Bore

### Contact Tips

Stock Code	Description
B B2504-10	Contact Tip .040"/1.0mm M6 ECu
B2504-12*	Contact Tip .045"/1.2mm M6 ECu
B2505-10	Contact Tip .040"/1.0mm M6 CuCrZr
B2505-12	Contact Tip .045"/1.2mm M6 CuCrZr
C B4014-10	Contact Tip .040"/1.0mm M8 ECu
B4014-12	Contact Tip .045"/1.2mm M8 ECu
B4015-10	Contact Tip .040"/1.0mm M8 CuCrZr
B4015-12	Contact Tip .045"/1.2mm M8 CuCrZr

### Liners

Stock Code	Description
D B2524-30*	Steel Liner .040"- .045"/1.0mm-1.2mm x 3m
B2524-40*	Steel Liner .040"- .045"/1.0mm-1.2mm x 4m
B2524-50*	Steel Liner .040"- .045"/1.0mm-1.2mm x 5m
B2513-30	Teflon Liner .040"- .045"/1.0mm-1.2mm x 3m
B2513-40	Teflon Liner .040"- .045"/1.0mm-1.2mm x 4m
B2513-50	Teflon Liner .040"- .045"/1.0mm-1.2mm x 5m

BZL

# Pro-Grip® 380A

## Air Cooled MIG Torch

350A CO<sub>2</sub>, 320A Mixed Gas @ 60% Duty Cycle, EN60974-7 .045"-1/16"/1.2mm to 1.6mm Wires

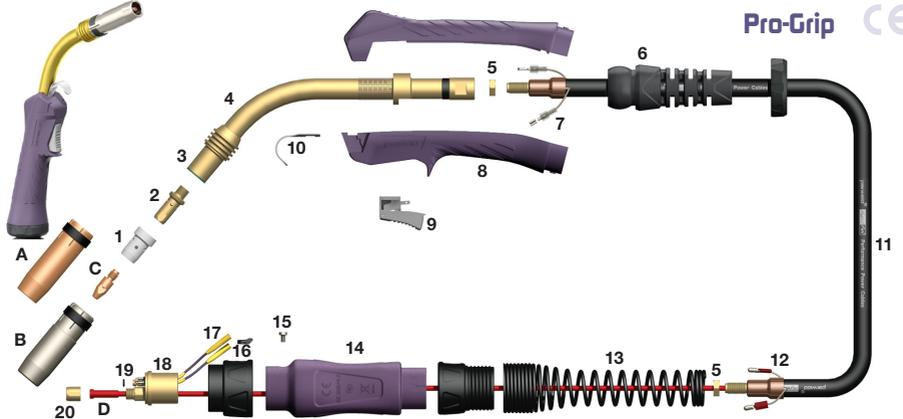

### Models

Stock Code	Description
B3800-30ER	Pro-Grip Torch Package c/w Euro Fitting x 3m
B3800-40ER	Pro-Grip Torch Package c/w Euro Fitting x 4m
B3800-50ER	Pro-Grip Torch Package c/w Euro Fitting x 5m

### Nozzles

Stock Code	Description
A B5027	Cylindrical Nozzle 3/4"/19mm Bore
B5028	Conical Nozzle 5/8"/16mm Bore
B5029	Tapered Nozzle 9/16"/14mm Bore
B B5028HD*	HD Conical Nozzle 5/8"/16mm Bore

### Contact Tips

Stock Code	Description
C B4014-12*	Contact Tip .045"/1.2mm M8 ECU
B4014-16	Contact Tip 1/16"/1.6mm M8 ECU
B4015-12	Contact Tip .045"/1.2mm M8 CuCrZr
B4015-16	Contact Tip 1/16"/1.6mm M8 CuCrZr

### Liners

Stock Code	Description
D B2524-30*	Steel Liner .040"-.045"/1.0mm-1.2mm x 3m
B2524-40*	Steel Liner .040"-.045"/1.0mm-1.2mm x 4m
B2524-50*	Steel Liner .040"-.045"/1.0mm-1.2mm x 5m
B3631-30	Steel Liner 1/16"/1.6mm x 3m
B3631-40	Steel Liner 1/16"/1.6mm x 4m
B3631-50	Steel Liner 1/16"/1.6mm x 5m Yellow
B2513-30	Teflon Liner .040"-.045"/1.0mm-1.2mm x 3m
B2513-40	Teflon Liner .040"-.045"/1.0mm-1.2mm x 4m
B2513-50	Teflon Liner .040"-.045"/1.0mm-1.2mm x 5m
B3626-30	Teflon Liner .045"-1/16"/1.2mm-1.6mm x 3m
B3626-40	Teflon Liner .045"-1/16"/1.2mm-1.6mm x 4m
B3626-50	Teflon Liner .045"-1/16"/1.2mm-1.6mm x 3m

### Components

\* Denotes Standard Build

Stock Code	Description
1 B5005B	Diffuser Black
B5005C*	Diffuser Ceramic
B5005W	Diffuser White
2 B3812	Tip Adaptor M8
3 B3803	Insulating Washer
4 B3801	Swan Neck
5 B1505	Lock Nut
6 B3841	Cable Support
7 B1521	Cable Terminal
8 B4514	Pro-Grip Handle Kit
9 B8516	Pro-Grip Trigger
10 B2517	Hanger Hook
11 B3609-30	Hyperflex™ Cable Assembly x 3m
B3609-40	Hyperflex™ Cable Assembly x 4m
B3609-50	Hyperflex™ Cable Assembly x 5m
12 B1522	Cable Terminal-Male
B18026	Spring Cable Support-Rear
14 B1518	Gun Plug Housing c/w Nut
15 B1526	Gun Plug Screw
16 B1519	Gun Plug Nut c/w Insert
17 Spring Pin 2	Spring Pin Assembly
18 B1528	Gun Plug Body c/w Spring Pins
19 B1524	Gun Plug 'O' Ring
20 B1525	Liner Nut

# Pro-Grip® 400A

## Air Cooled MIG Torch

350A CO<sub>2</sub>, 320A Mixed Gas @ 60% Duty Cycle, EN60974-7 .040"-3/32"/1.0mm to 2.4mm Wires

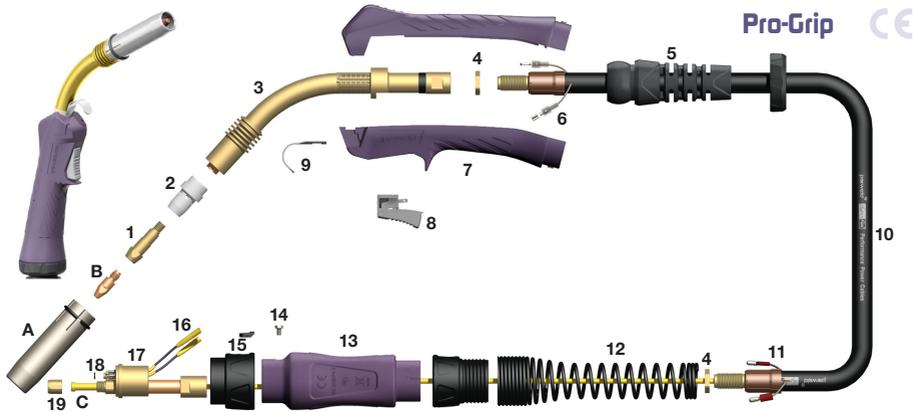

### Models

Stock Code	Description
B4000-30ER	Pro-Grip Torch Package c/w Euro Fitting x 3m
B4000-40ER	Pro-Grip Torch Package c/w Euro Fitting x 4m
B4000-50ER	Pro-Grip Torch Package c/w Euro Fitting x 5m

### Nozzles

Stock Code	Description
A B4017*	Conical Nozzle 5/7"/18mm Bore

### Contact Tips

Stock Code	Description
B B4014-10	Contact Tip .040"/1.0mm M8 ECU
B4014-12*	Contact Tip .045"/1.2mm M8 ECU
B4014-16	Contact Tip 1/16"/1.6mm M8 ECU
B4014-24	Contact Tip .090"/2.4mm M8 ECU
B4015-10	Contact Tip .040"/1.0mm M8 CuCrZr
B4015-12	Contact Tip .045"/1.2mm M8 CuCrZr
B4015-16	Contact Tip 1/16"/1.6mm M8 CuCrZr
B4015-24	Contact Tip .090"/2.4mm M8 CuCrZr

### Liners

Stock Code	Description
C B2524-30	Steel Liner .040"- .045"/1.0mm-1.2mm x 3m
B2524-40	Steel Liner .040"- .045"/1.0mm-1.2mm x 4m
B2524-50	Steel Liner .040"- .045"/1.0mm-1.2mm x 5m
B3631-30*	Steel Liner 1/16"/1.6mm x 3m
B3631-40*	Steel Liner 1/16"/1.6mm x 4m
B3631-50*	Steel Liner 1/16"/1.6mm x 5m Yellow
B4631-30	Steel Liner .080"- .090"/2.0mm-2.4mm x 3m
B4631-40	Steel Liner .080"- .090"/2.0mm-2.4mm x 4m
B4631-50	Steel Liner .080"- .090"/2.0mm-2.4mm x 5m
B2513-30	Teflon Liner .040"- .045"/1.0mm-1.2mm x 3m
B2513-40	Teflon Liner .040"- .045"/1.0mm-1.2mm x 4m
B2513-50	Teflon Liner .040"- .045"/1.0mm-1.2mm x 5m

### Components

\* Denotes Standard Build

Stock Code	Description
1 B4005	Tip Adaptor M8
2 B4003B	Diffuser Black
3 B4003C*	Diffuser Ceramic
3 B4002	Swan Neck
4 B4050	Lock Nut
5 B3841	Cable Support
6 B1521	Cable Terminal
7 B4514	Pro-Grip Handle Kit
8 B8516	Pro-Grip Trigger
9 B2517	Hanger Hook
10 B4010-30	Hyperflex™ Cable Assembly x 3m
B4010-40	Hyperflex™ Cable Assembly x 4m
B4010-50	Hyperflex™ Cable Assembly x 5m
11 B1522	Cable Terminal-Male
12 B8026	Spring Cable Support-Rear
13 B1518	Gun Plug Housing c/w Nut
14 B1526	Gun Plug Screw
15 B1519	Gun Plug Nut c/w Insert
16 Spring Pin 2	Spring Pin Assembly
17 B4038	Gun Plug Body c/w Spring Pins
18 B1524	Gun Plug 'O' Ring
19 B1525	Liner Nut

## Pro-Grip Max® 240W

### Water Cooled MIG Welding Torch

300A CO<sub>2</sub>, 270A Mixed Gas @ 100% Duty Cycle, EN60974-7 .030"- .045"/0.8mm to 1.2mm Wires

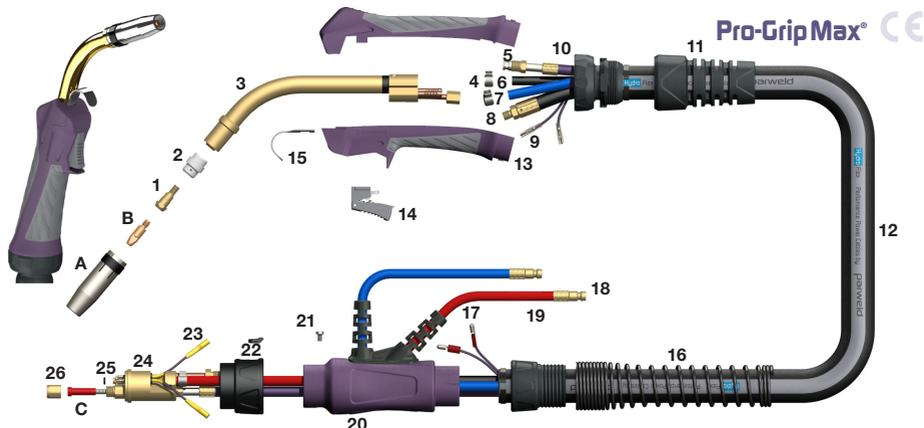

#### Models

Stock Code	Description
PRO2400W-30ER	Pro-Grip Max® Torch c/w Euro Fitting x 3m
PRO2400W-40ER	Pro-Grip Max® Torch c/w Euro Fitting x 4m
PRO2400W-50ER	Pro-Grip Max® Torch c/w Euro Fitting x 5m

#### Nozzles

Stock Code	Description
A B2415	Cylindrical Nozzle 11/16"/17mm Bore
B2416*	Conical Nozzle 1/2"/13mm Bore
B2417	Tapered Nozzle 3/8"/10mm Bore

#### Contact Tips

Stock Code	Description
B B2504-08	Contact Tip .030"/0.8mm M6 Ecu
B2504-09	Contact Tip .035"/0.9mm M6 Ecu
B2504-10*	Contact Tip .040"/1.0mm M6 Ecu
B2504-12	Contact Tip .045"/1.2mm M6 Ecu
B2505-08	Contact Tip .030"/0.8mm M6 CuCrZr
B2505-09	Contact Tip .035"/0.9mm M6 CuCrZr
B2505-10	Contact Tip .040"/1.0mm M6 CuCrZr
B2505-12	Contact Tip .045"/1.2mm M6 CuCrZr

#### Liners

Stock Code	Description
C B5033-30*	Plain Liner .040"- .045"/1.0mm-1.2mm x 3m
B5033-40*	Plain Liner .040"- .045"/1.0mm-1.2mm x 4m
B5033-50*	Plain Liner .040"- .045"/1.0mm-1.2mm x 5m
B1536-30	Teflon Liner .023"- .035"/0.6mm-0.9mm x 3m
B1536-40	Teflon Liner .023"- .035"/0.6mm-0.9mm x 4m
B1536-50	Teflon Liner .023"- .035"/0.6mm-0.9mm x 5m
B2513-30	Teflon Liner .040"- .045"/1.0mm-1.2mm x 3m
B2513-40	Teflon Liner .040"- .045"/1.0mm-1.2mm x 4m

#### Components

\* Denotes Standard Build

Stock Code	Description
1 B2412	Tip Adaptor M6
2 B2405B	Diffuser Black
B2405C*	Diffuser Ceramic
B2405W	Diffuser White
3 B2409	Swan Neck
4 B5024	Water Hose Clamp 9.5mm
5 B5008-40	Outer Liner Assembly x 4m
B5008-50	Outer Liner Assembly x 5m
6 B5013-40	Gas Hose Assembly x 4m
B5013-50	Gas Hose Assembly x 5m
7 B5012-40	Water Inlet Hose Assembly x 4m
B5012-50	Water Inlet Hose Assembly x 5m
8 B5015-40	Power Cable Assembly x 4m
B5015-50	Power Cable Assembly x 5m
9 B5010-40	Switch Lead Assembly x 4m
B5010-50	Switch Lead Assembly x 5m
10 B8031	Ball Joint Assembly c/w Clamp
11 B8032	Spring Cable Support c/w Adaptor
12 B5019-40	Canvas Cover Assembly x 4m
B5019-50	Canvas Cover Assembly x 5m
13 B8594	Pro-Grip Max® Handle Kit
14 B8516	Pro-Grip Max® Trigger
15 B2517	Hanger Hook
16 B8027	Spring Cable Support-Rear
17 B1522	Cable Terminal-Male
18 B5023	Water Hose Nipple
19 B5017	Water Outlet Hose O/Braid
20 B5022	Gun Plug Housing c/w Lock Nut and Hose Supports
21 B1526	Gun Plug Screw
22 B1519	Gun Plug Nut c/w Insert
23 Spring Pin 2	Spring Pin Assembly
24 B5098	Gun Plug Body c/w Spring Pins
25 B1524	Gun Plug 'O' Ring
26 B1525	Liner Nut

# Pro-Grip Max® 350W

## Water Cooled MIG Welding Torch

320A CO<sub>2</sub>, 280A Mixed Gas @ 100% Duty Cycle, EN60974-7 .030"-.045"/0.8mm to 1.2mm Wires

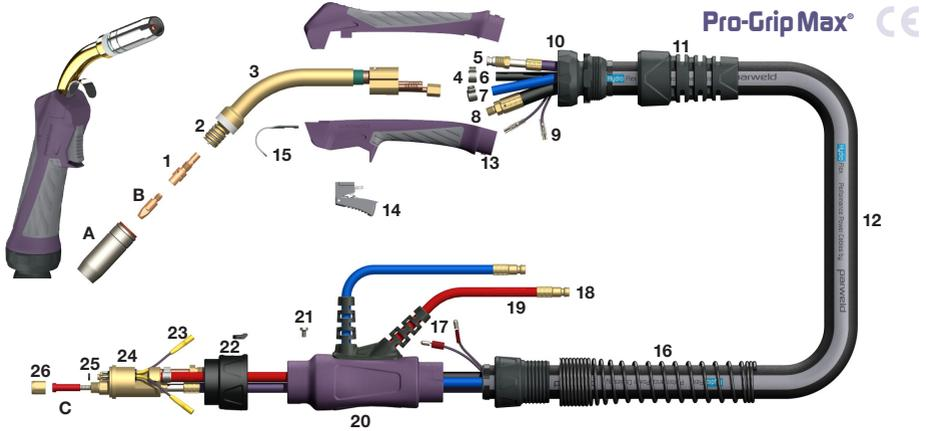

### Models

Stock Code	Description
PRO3500-30ER	Pro-Grip Max® Torch c/w Euro Fitting x 3m
PRO3500-40ER	Pro-Grip Max® Torch c/w Euro Fitting x 4m
PRO3500-50ER	Pro-Grip Max® Torch c/w Euro Fitting x 5m

### Nozzles

Stock Code	Description
A B2507	Cylindrical Nozzle 5/7"x18mm Bore
B2508*	Conical Nozzle 19/32"x15mm Bore
B2509	Tapered Nozzle 15/32"x12mm Bore

### Contact Tips

Stock Code	Description
B B2504-08	Contact Tip .030"/0.8mm M6 ECU
B2504-09	Contact Tip .035"/0.9mm M6 ECU
B2504-10*	Contact Tip .040"/1.0mm M6 ECU
B2505-08	Contact Tip .030"/0.8mm M6 CuCrZr
B2505-09	Contact Tip .035"/0.9mm M6 CuCrZr
B2505-10	Contact Tip .040"/1.0mm M6 CuCrZr
B2505-12	Contact Tip .045"/1.2mm M6 CuCrZr

### Liners

Stock Code	Description
C B5033-30*	Plain Liner .040"-.045"/1.0mm-1.2mm x 3m
B5033-40*	Plain Liner .040"-.045"/1.0mm-1.2mm x 4m
B5033-50*	Plain Liner .040"-.045"/1.0mm-1.2mm x 5m
B1536-30	Teflon Liner .023*-.035"/0.6mm-0.9mm x 3m
B1536-40	Teflon Liner .023*-.035"/0.6mm-0.9mm x 4m
B1536-50	Teflon Liner .023*-.035"/0.6mm-0.9mm x 5m
B2513-30	Teflon Liner .040"-.045"/1.0mm-1.2mm x 3m
B2513-40	Teflon Liner .040"-.045"/1.0mm-1.2mm x 4m

### Components

\* Denotes Standard Build

Stock Code	Description
1 B2506	Tip Adaptor M6
2 B2502	Shroud Spring
3 B3501	Swan Neck
4 B5024	Water Hose Clamp 9.5mm
5 B5008-40	Outer Liner Assembly x 4m
B5008-50	Outer Liner Assembly x 5m
6 B5013-40	Gas Hose Assembly x 4m
B5013-50	Gas Hose Assembly x 5m
7 B5012-40	Water Inlet Hose Assembly x 4m
B5012-50	Water Inlet Hose Assembly x 5m
8 B5015-40	Power Cable Assembly x 4m
B5015-50	Power Cable Assembly x 5m
9 B5010-40	Switch Lead Assembly x 4m
B5010-50	Switch Lead Assembly x 5m
10 B8031	Ball Joint Assembly c/w Clamp
11 B8032	Spring Cable Support c/w Adaptor
12 B5019-40	Canvas Cover Assembly x 4m
B5019-50	Canvas Cover Assembly x 5m
13 B8594	Pro-Grip Max® Handle Kit
14 B8516	Pro-Grip Max® Trigger
15 B2517	Hanger Hook
16 B8027	Spring Cable Support-Rear
17 B1522	Cable Terminal-Male
18 B5023	Water Hose Nipple
19 B5017	Water Outlet Hose O/Braid
20 B5022	Gun Plug Housing c/w Lock Nut and Hose Supports
21 B1526	Gun Plug Screw
22 B1519	Gun Plug Nut c/w Insert
23 Spring Pin 2	Spring Pin Assembly
24 B5098	Gun Plug Body c/w Spring Pins
25 B1524	Gun Plug 'O' Ring
26 B1525	Liner Nut

# Pro-Grip Max® 401W

## Water Cooled MIG Welding Torch

400A CO<sub>2</sub>, 350A Mixed Gas @ 100% Duty Cycle, EN60974-7 .030"- .045"/0.8mm to 1.2mm Wires

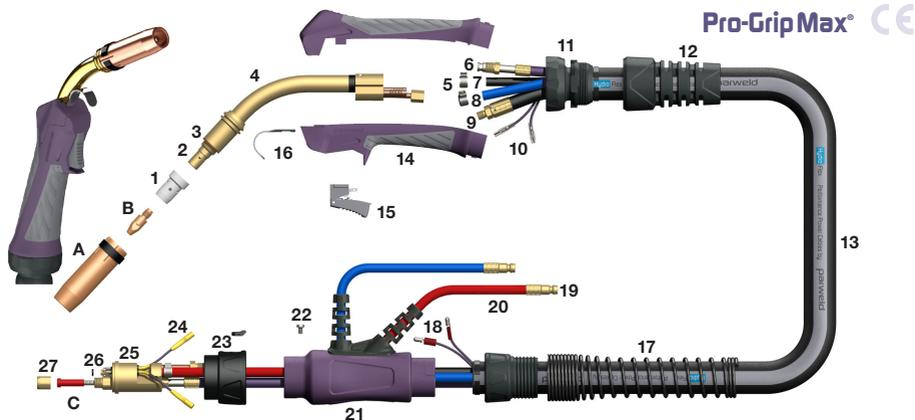

### Models

Stock Code	Description
PRO4001-30ER	Pro-Grip Max® Torch Package c/w Euro Fitting x 3m
PRO4001-40ER	Pro-Grip Max® Torch Package c/w Euro Fitting x 4m
PRO4001-50ER	Pro-Grip Max® Torch Package c/w Euro Fitting x 5m

### Nozzles

Stock Code	Description
A B5027	Cylindrical Nozzle 3/4"/19mm Bore
B5028*	Conical Nozzle 5/8"/16mm Bore
B5029	Tapered Nozzle 15/32"/12mm Bore

### Contact Tips

Stock Code	Description
B B4014-08	Contact Tip .030"/0.8mm M8 ECU
B4014-10	Contact Tip .040"/1.0mm M8 ECU
B4014-12*	Contact Tip .045"/1.2mm M8 ECU
B4015-10	Contact Tip .040"/1.0mm M8 CuCrZr
B4015-12	Contact Tip .045"/1.2mm M8 CuCrZr

### Liners

Stock Code	Description
C B5033-30*	Plain Liner .040"- .045"/1.0mm-1.2mm x 3m
B5033-40*	Plain Liner .040"- .045"/1.0mm-1.2mm x 4m
B5033-50*	Plain Liner .040"- .045"/1.0mm-1.2mm x 5m
B2513-30	Teflon Liner .040"- .045"/1.0mm-1.2mm x 3m
B2513-40	Teflon Liner .040"- .045"/1.0mm-1.2mm x 4m
B2513-50	Teflon Liner .040"- .045"/1.0mm-1.2mm x 5m

### Components

\* Denotes Standard Build

Stock Code	Description
1 B5005B	Diffuser Black
B5005C*	Diffuser Ceramic
B5005W	Diffuser White
2 B5001	Tip Adaptor 1"/25mm M8
3 B5003	Insulating Washer
4 B4011	Swan Neck
5 B5024	Water Hose Clamp 9.5mm
6 B5008-40	Outer Liner Assembly x 4m
B5008-50	Outer Liner Assembly x 5m
7 B5013-40	Gas Hose Assembly x 4m
B5013-50	Gas Hose Assembly x 5m
8 B5012-40	Water Inlet Hose Assembly x 4m
B5012-50	Water Inlet Hose Assembly x 5m
9 B5015-40	Power Cable Assembly x 4m
B5015-50	Power Cable Assembly x 5m
10 B5010-40	Switch Lead Assembly x 4m
B5010-50	Switch Lead Assembly x 5m
11 B8031	Ball Joint Assembly c/w Clamp
12 B8032	Spring Cable Support c/w Adaptor
13 B5019-40	Canvas Cover Assembly x 4m
B5019-50	Canvas Cover Assembly x 5m
14 B8594	Pro-Grip Max® Handle Kit
15 B8516	Pro-Grip Max® Trigger
16 B2517	Hanger Hook
17 B8027	Spring Cable Support-Rear
18 B1522	Cable Terminal-Male
19 B5023	Water Hose Nipple
20 B5017	Water Outlet Hose O/Braid
21 B5022	Gun Plug Housing c/w Lock Nut and Hose Supports
22 B1526	Gun Plug Screw
23 B1519	Gun Plug Nut c/w Insert
24 Spring Pin 2	Spring Pin Assembly
25 B5098	Gun Plug Body c/w Spring Pins
26 B1524	Gun Plug 'O' Ring
27 B1525	Liner Nut

# Pro-Grip Max® 501W

## Water Cooled MIG Welding Torch

520A CO<sub>2</sub>, 430A Mixed Gas @ 100% Duty Cycle, EN60974-7 .040"-1/16"/1.0mm to 1.6mm Wires

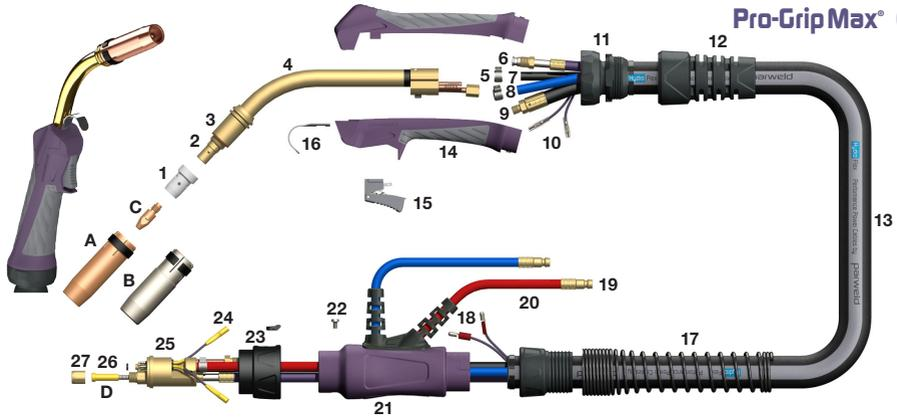

### Models

Stock Code	Description
PRO5000-30ER	Pro-Grip Max® Torch Package c/w Euro Fitting x 3m
PRO5000-40ER	Pro-Grip Max® Torch Package c/w Euro Fitting x 4m
PRO5000-50ER	Pro-Grip Max® Torch Package c/w Euro Fitting x 5m

### Nozzles

Stock Code	Description
A B5027	Cylindrical Nozzle 3/4"/19mm Bore
B5028*	Conical Nozzle 5/8"/16mm Bore
B5029	Tapered Nozzle 9/16"/14mm Bore
B B5028HD	HD Conical Nozzle 5/8"/16mm Bore

### Contact Tips

Stock Code	Description
C B4014-10	Contact Tip .040"/1.0mm M8 ECu
B4014-12*	Contact Tip .045"/1.2mm M8 ECu
B4014-16	Contact Tip 1/16"/1.6mm M8 ECu
B4015-12	Contact Tip .045"/1.2mm M8 CuCrZr
B4015-16	Contact Tip 1/16"/1.6mm M8 CuCrZr

### Liners

Stock Code	Description
D B5033-30	Plain Liner .040"-.045"/1.0mm-1.2mm x 3m
B5033-40	Plain Liner .040"-.045"/1.0mm-1.2mm x 4m
B5033-50	Plain Liner .040"-.045"/1.0mm-1.2mm x 5m
B5034-30*	Plain Liner .045"-1/16"/1.2mm-1.6mm x 3m
B5034-40*	Plain Liner .045"-1/16"/1.2mm-1.6mm x 4m
B5034-50	Plain Liner .045"-1/16"/1.2mm-1.6mm x 5m
B2513-30	Teflon Liner .040"-.045"/1.0mm-1.2mm x 3m
B2513-40	Teflon Liner .040"-.045"/1.0mm-1.2mm x 4m
B2513-50	Teflon Liner .040"-.045"/1.0mm-1.2mm x 5m
B3626-30	Teflon Liner .045"-1/16"/1.2mm-1.6mm x 3m
B3626-40	Teflon Liner .045"-1/16"/1.2mm-1.6mm x 4m
B3626-50	Teflon Liner .045"-1/16"/1.2mm-1.6mm x 5m

### Components

\* Denotes Standard Build

Stock Code	Description
1 B5005B	Diffuser Black
B5005C*	Diffuser Ceramic
B5005W	Diffuser White
2 B5001	Tip Adaptor 1"/25mm M8
3 B5003	Insulating Washer
4 B5002	Swan Neck
5 B5024	Water Hose Clamp 9.5mm
6 B5008-40	Outer Liner Assembly x 4m
B5008-50	Outer Liner Assembly x 5m
7 B5013-40	Gas Hose Assembly x 4m
B5013-50	Gas Hose Assembly x 5m
8 B5012-40	Water Inlet Hose Assembly x 4m
B5012-50	Water Inlet Hose Assembly x 5m
9 B5015-40	Power Cable Assembly x 4m
B5015-50	Power Cable Assembly x 5m
10 B5010-40	Switch Lead Assembly x 4m
B5010-50	Switch Lead Assembly x 5m
11 B8031	Ball Joint Assembly c/w Clamp
12 B8032	Spring Cable Support c/w Adaptor
13 B5019-40	Canvas Cover Assembly x 4m
B5019-50	Canvas Cover Assembly x 5m
14 B8594	Pro-Grip Max® Handle Kit
15 B8516	Pro-Grip Max® Trigger
16 B2517	Hanger Hook
17 B8027	Spring Cable Support-Rear
18 B1522	Cable Terminal-Male
19 B5023	Water Hose Nipple
20 B5017	Water Outlet Hose O/Braid
21 B5022	Gun Plug Housing c/w Lock Nut and Hose Supports
22 B1526	Gun Plug Screw
23 B1519	Gun Plug Nut c/w Insert
24 Spring Pin 2	Spring Pin Assembly
25 B5098	Gun Plug Body c/w Spring Pins
26 B1524	Gun Plug 'O' Ring
27 B1525	Liner Nut

## Pro-Grip Max® 501W EXT

### Water Cooled MIG Welding Torch

520A CO<sub>2</sub>, 430A Mixed Gas @ 100% Duty Cycle, EN60974-7 .040"-1/16"/1.0mm to 1.6mm Wires

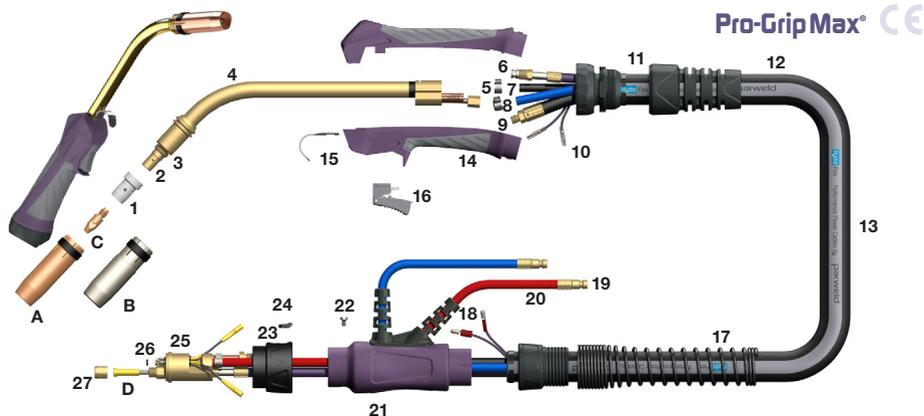

#### Models

Stock Code	Description
PRO500L-30ER	Pro-Grip Max® Torch Package c/w Euro Fitting x 3m
PRO500L-40ER	Pro-Grip Max® Torch Package c/w Euro Fitting x 4m
PRO500L-50ER	Pro-Grip Max® Torch Package c/w Euro Fitting x 5m

#### Nozzles

Stock Code	Description
A B5027	Cylindrical Nozzle 3/4"/19mm Bore
B5028*	Conical Nozzle 5/8"/16mm Bore
B5029	Tapered Nozzle 9/16"/14mm Bore
B B5028HD	HD Conical Nozzle 5/8"/16mm Bore

#### Contact Tips

Stock Code	Description
C B4014-10	Contact Tip .040"/1.0mm M8 ECu
B4014-12*	Contact Tip .045"/1.2mm M8 ECu
B4014-16	Contact Tip 1/16"/1.6mm M8 ECu
B4015-12	Contact Tip .045"/1.2mm M8 CuCrZr
B4015-16	Contact Tip 1/16"/1.6mm M8 CuCrZr

#### Liners

Stock Code	Description
D B5033-30	Plain Liner .040"- .045"/1.0mm-1.2mm x 3m
B5033-40	Plain Liner .040"- .045"/1.0mm-1.2mm x 4m
B5033-50	Plain Liner .040"- .045"/1.0mm-1.2mm x 5m
B5034-30*	Plain Liner .045"-1/16"/1.2mm-1.6mm x 3m
B5034-40*	Plain Liner .045"-1/16"/1.2mm-1.6mm x 4m
B5034-50*	Plain Liner .045"-1/16"/1.2mm-1.6mm x 5m
B2513-30	Teflon Liner .040"- .045"/1.0mm-1.2mm x 3m
B2513-40	Teflon Liner .040"- .045"/1.0mm-1.2mm x 4m
B2513-50	Teflon Liner .040"- .045"/1.0mm-1.2mm x 5m
B3626-30	Teflon Liner .045"-1/16"/1.2mm-1.6mm x 3m
B3626-40	Teflon Liner .045"-1/16"/1.2mm-1.6mm x 4m
B3626-50	Teflon Liner .045"-1/16"/1.2mm-1.6mm x 5m

#### Components

\* Denotes Standard Build

Stock Code	Description
1 B5005B	Diffuser Black
B5005C*	Diffuser Ceramic
B5005W	Diffuser White
2 B5001	Tip Adaptor 1"/25mm M8
3 B5003	Insulating Washer
4 B5002L	Extended Length Swan Neck
5 B5024	Water Hose Clamp 9.5mm
6 B5008-40	Outer Liner Assembly x 4m
B5008-50	Outer Liner Assembly x 5m
7 B5013-40	Gas Hose Assembly x 4m
B5013-50	Gas Hose Assembly x 5m
8 B5012-40	Water Inlet Hose Assembly x 4m
B5012-50	Water Inlet Hose Assembly x 5m
9 B5015-40	Power Cable Assembly x 4m
B5015-50	Power Cable Assembly x 5m
10 B5010-40	Switch Lead Assembly x 4m
B5010-50	Switch Lead Assembly x 5m
11 B8031	Ball Joint Assembly c/w Clamp
12 B8032	Spring Cable Support c/w Adaptor
13 B5019-40	Canvas Cover Assembly x 4m
B5019-50	Canvas Cover Assembly x 5m
14 B8594	Pro-Grip Max® Handle Kit
15 B2517	Hanger Hook
16 B8516	Pro-Grip Max® Trigger
17 B8027	Spring Cable Support-Rear
18 B1522	Cable Terminal-Male
19 B5023	Water Hose Nipple
20 B5017	Water Outlet Hose O/Braid
21 B5022	Gun Plug Housing c/w Lock Nut and Hose Supports
22 B1526	Gun Plug Screw
23 B1519	Gun Plug Nut c/w Insert
24 B5024	Spring Pin Assembly
25 B5098	Gun Plug Body c/w Spring Pins
26 B1524	Gun Plug 'O' Ring
27 B1525	Liner Nut

# SB 501W Auto

## Water Cooled Automatic MIG Welding Torch

520A CO<sub>2</sub>, 430A Mixed Gas @ 100% Duty Cycle, EN60974-7 .040"-1/16"/1.0mm to 1.6mm Wires

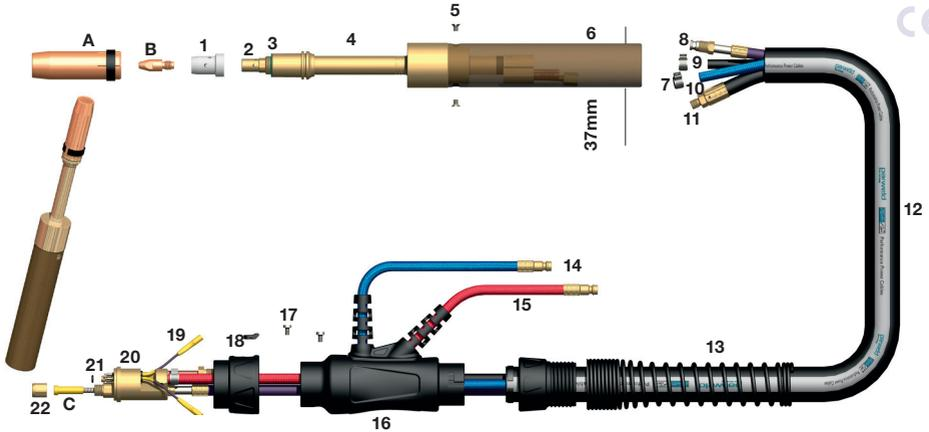

BZL

### Models

Stock Code	Description
B5000-20A	Auto Welding Torch Package c/w Euro Fitting x 2m
B5000-30A	Auto Welding Torch Package c/w Euro Fitting x 3m
B5000-40A	Auto Welding Torch Package c/w Euro Fitting x 4m

### Nozzles

Stock Code	Description
A B5027	Cylindrical Nozzle 3/4"/19mm Bore
B5028*	Conical Nozzle 5/8"/16mm Bore
B5029	Tapered Nozzle 9/16"/14mm Bore

### Contact Tips

Stock Code	Description
B B4014-10	Contact Tip .040"/1.0mm M8 ECU
B4014-12*	Contact Tip .045"/1.2mm M8 ECU
B4014-16	Contact Tip 1/16"/1.6mm M8 ECU
B4015-10	Contact Tip .040"/1.0mm M8 CuCrZr
B4015-12	Contact Tip .045"/1.2mm M8 CuCrZr
B4015-16	Contact Tip 1/16"/1.6mm M8 CuCrZr

### Liners

Stock Code	Description
C B5033-30	Plain Liner .040"-.045"/1.0mm-1.2mm x 3m
B5033-40	Plain Liner .040"-.045"/1.0mm-1.2mm x 4m
B5034-30*	Plain Liner .045"-1/16"/1.2mm-1.6mm x 3m
B5034-40*	Plain Liner .045"-1/16"/1.2mm-1.6mm x 4m
B4033-30	Plain Liner .080"-.090"/2.0mm-2.4mm x 3m
B4033-40	Plain Liner .080"-.090"/2.0mm-2.4mm x 4m
B2513-30	Teflon Liner .040"-.045"/1.0mm-1.2mm x 3m
B2513-40	Teflon Liner .040"-.045"/1.0mm-1.2mm x 4m
B3626-30	Teflon Liner .045"-1/16"/1.2mm-1.6mm x 3m
B3626-40	Teflon Liner .045"-1/16"/1.2mm-1.6mm x 4m

### Components

\* Denotes Standard Build

Stock Code	Description
1 B5005B	Diffuser Black
B5005C*	Diffuser Ceramic
B5005W	Diffuser White
2 B5001	Tip Adaptor 1"/250.0mm M8
3 B5003	Insulating Washer
4 B5002A	Auto Straight Neck
5 B3629	Handle Screw
6 B3630	Automatic Handle
7 B5024	Water Hose Clamp 9.5mm
8 B5008-30	Outer Liner Assembly x 3m
B5008-40	Outer Liner Assembly x 4m
B5008-50	Outer Liner Assembly x 5m
9 B5013-30	Gas Hose Assembly x 3m
B5013-40	Gas Hose Assembly x 4m
B5013-50	Gas Hose Assembly x 5m
10 B5012-30	Water Inlet Hose Assembly x 3m
B5012-40	Water Inlet Hose Assembly x 4m
B5012-50	Water Inlet Hose Assembly x 5m
11 B5015-30	Power Cable Assembly x 3m
B5015-40	Power Cable Assembly x 4m
B5015-50	Power Cable Assembly x 5m
12 B5019-30	Canvas Cover Assembly x 3m
B5019-40	Canvas Cover Assembly x 4m
B5019-50	Canvas Cover Assembly x 5m
13 B8027	Spring Cable Support-Rear
14 B5023	Water Hose Nipple
15 B5017	Water Outlet Hose O/Braid
16 B5022/BK	Gun Plug Housing c/w Locknut & Support-Black
17 B1526	Gun Plug Screw-Black
18 B1519/BK	Gun Plug Nut-Black
19 Spring Pin 2	Spring Pin Assembly
20 B5098	Gun Plug Body c/w Spring Pins
21 B1524	Gun Plug 'O' Ring
22 B1525	Liner Nut

## Pro-Grip Max® 400W - NEW

Double Cooled Water Cooled MIG Welding Torch ideal for synergic and pulse applications

400A CO<sub>2</sub>, 350A Mixed Gas @ 100% Duty Cycle, EN60974-7 .030"-.045"/0.8mm to 1.2mm Wires

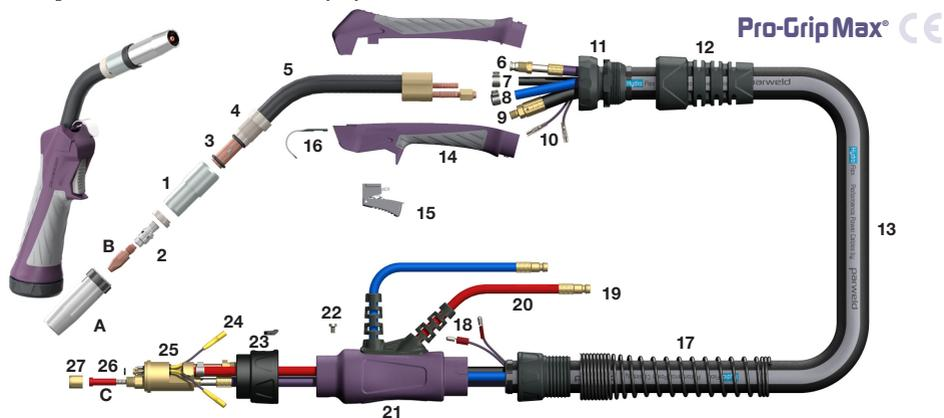

### Models

Stock Code	Description
PRO4400-30ER	Pro-Grip Max® Torch Package c/w Euro Fitting x 3m
PRO4400-40ER	Pro-Grip Max® Torch Package c/w Euro Fitting x 4m
PRO4400-50ER	Pro-Grip Max® Torch Package c/w Euro Fitting x 5m

### Nozzles

Stock Code	Description
A B4408	Cylindrical Nozzle 3/4"/19mm Bore
B4407	Conical Nozzle 5/8"/16mm Bore
B4409	Tapered Nozzle 9/16"/14mm Bore

### Contact Tips

Stock Code	Description
B B4014-10	Contact Tip .040"/1.0mm M8 Ecu
B4014-12*	Contact Tip .045"/1.2mm M8 Ecu
B4014-16	Contact Tip 1/16"/1.6mm M8 Ecu
B4015-12	Contact Tip .045"/1.2mm M8 CuCrZr
B4015-16	Contact Tip 1/16"/1.6mm M8 CuCrZr

### Liners

Stock Code	Description
C B5033-30	Plain Liner .040"-.045"/1.0mm-1.2mm x 3m
B5033-40	Plain Liner .040"-.045"/1.0mm-1.2mm x 4m
B5033-50	Plain Liner .040"-.045"/1.0mm-1.2mm x 5m
B5034-30*	Plain Liner .045"-1/16"/1.2mm-1.6mm x 3m
B5034-40*	Plain Liner .045"-1/16"/1.2mm-1.6mm x 4m
B5034-50	Plain Liner .045"-1/16"/1.2mm-1.6mm x 5m
B2513-30	Teflon Liner .040"-.045"/1.0mm-1.2mm x 3m
B2513-40	Teflon Liner .040"-.045"/1.0mm-1.2mm x 4m
B2513-50	Teflon Liner .040"-.045"/1.0mm-1.2mm x 5m
B3626-30	Teflon Liner .045"-1/16"/1.2mm-1.6mm x 3m
B3626-40	Teflon Liner .045"-1/16"/1.2mm-1.6mm x 4m
B3626-50	Teflon Liner .045"-1/16"/1.2mm-1.6mm x 5m

### Components

\* Denotes Standard Build

Stock Code	Description
1 B4403	Isolating Ring
2 B5001	Tip Adaptor 1"/25mm M8
3 B4409	O Ring Pack
4 B4410	Nozzle Seat
5 B4402	Swan Neck
B5024	Water Hose Clamp 9.5mm
6 B5008-40	Outer Liner Assembly x 4m
B5008-50	Outer Liner Assembly x 5m
7 B5013-40	Gas Hose Assembly x 4m
B5013-50	Gas Hose Assembly x 5m
8 B5012-40	Water Inlet Hose Assembly x 4m
B5012-50	Water Inlet Hose Assembly x 5m
9 B5015-40	Power Cable Assembly x 4m
B5015-50	Power Cable Assembly x 5m
10 B5010-40	Switch Lead Assembly x 4m
B5010-50	Switch Lead Assembly x 5m
11 B8031	Ball Joint Assembly c/w Clamp
12 B8032	Spring Cable Support c/w Adaptor
13 B5019-40	Canvas Cover Assembly x 4m
B5019-50	Canvas Cover Assembly x 5m
14 B8594	Pro-Grip Max® Handle Kit
15 B8516	Pro-Grip Max® Trigger
16 B2517	Hanger Hook
17 B8027	Spring Cable Support-Rear
18 B1522	Cable Terminal-Male
19 B5023	Water Hose Nipple
20 B5017	Water Outlet Hose O/Braid
21 B5022	Gun Plug Housing c/w Lock Nut and Hose Supports
22 B1526	Gun Plug Screw
23 B1519	Gun Plug Nut c/w Insert
24 Spring Pin 2	Spring Pin Assembly
25 B5098	Gun Plug Body c/w Spring Pins
26 B1524	Gun Plug 'O' Ring
27 B1525	Liner Nut

# Pro-Grip® 550W - NEW

**Double Cooled Water Cooled MIG Welding Torch ideal for synergic and pulse applications**

550A CO<sub>2</sub>, 500A Mixed Gas @ 100% Duty Cycle, EN60974-7 .030"-1/16"/0.8mm to 1.6mm Wires

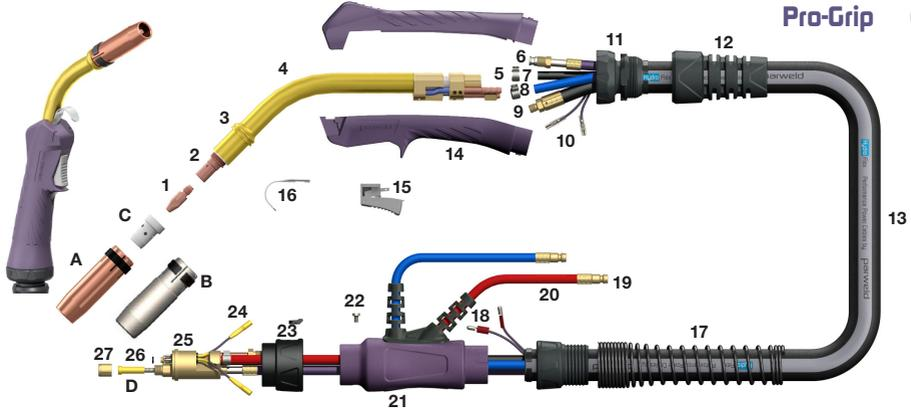

Models	Components
--------	------------

Stock Code	Description
B5500-30ER	Pro-Grip Torch Package c/w Euro Fitting x 3m
B5500-40ER	Pro-Grip Torch Package c/w Euro Fitting x 4m
B5500-50ER	Pro-Grip Torch Package c/w Euro Fitting x 5m

\* Denotes Standard Build

### Nozzles

Stock Code	Description
<b>A</b> B5027	Cylindrical Nozzle 3/4"/19mm Bore
B5028*	Conical Nozzle 5/8"/16mm Bore
B5029	Tapered Nozzle 9/16"/14mm Bore
<b>B</b> B5028HD	HD Conical Nozzle 5/8"/16mm Bore

### Contact Tips

Stock Code	Description
<b>C</b> B4014-10	Contact Tip .040"/1.0mm M8 ECU
B4014-12*	Contact Tip .045"/1.2mm M8 ECU
B4014-16	Contact Tip 1/16"/1.6mm M8 ECU
B4015-12	Contact Tip .045"/1.2mm M8 CuCrZr
B4015-16	Contact Tip 1/16"/1.6mm M8 CuCrZr

### Liners

Stock Code	Description
<b>D</b> B5033-30	Plain Liner .040"-.045"/1.0mm-1.2mm x 3m
B5033-40	Plain Liner .040"-.045"/1.0mm-1.2mm x 4m
B5033-50	Plain Liner .040"-.045"/1.0mm-1.2mm x 5m
B5034-30*	Plain Liner .045"-1/16"/1.2mm-1.6mm x 3m
B5034-40*	Plain Liner .045"-1/16"/1.2mm-1.6mm x 4m
B5034-50	Plain Liner .045"-1/16"/1.2mm-1.6mm x 5m
B2513-30	Teflon Liner .040"-.045"/1.0mm-1.2mm x 3m
B2513-40	Teflon Liner .040"-.045"/1.0mm-1.2mm x 4m
B2513-50	Teflon Liner .040"-.045"/1.0mm-1.2mm x 5m
B3626-30	Teflon Liner .045"-1/16"/1.2mm-1.6mm x 3m
B3626-40	Teflon Liner .045"-1/16"/1.2mm-1.6mm x 4m
B3626-50	Teflon Liner .045"-1/16"/1.2mm-1.6mm x 5m

1 B5005B	Diffuser Black
B5005C*	Diffuser Ceramic
B5005W	Diffuser White
2 B5512	Tip Adaptor 1"/25mm M8 Copper
3 B5503	Insulating Washer
4 B5502	Swan Neck
5 B5024	Water Hose Clamp 9.5mm
6 B5008-40	Outer Liner Assembly x 4m
B5008-50	Outer Liner Assembly x 5m
7 B5013-40	Gas Hose Assembly x 4m
B5013-50	Gas Hose Assembly x 5m
8 B5012-40	Water Inlet Hose Assembly x 4m
B5012-50	Water Inlet Hose Assembly x 5m
9 B5015-40	Power Cable Assembly x 4m
B5015-50	Power Cable Assembly x 5m
10 B5010-40	Switch Lead Assembly x 4m
B5010-50	Switch Lead Assembly x 5m
11 B8031	Ball Joint Assembly c/w Clamp
12 B8032	Spring Cable Support c/w Adaptor
13 B5019-40	Canvas Cover Assembly x 4m
B5019-50	Canvas Cover Assembly x 5m
14 B4514	Handle Kit - Large
15 B8516	Trigger
16 B2517	Hanger Hook
17 B8027	Spring Cable Support-Rear
18 B1522	Cable Terminal-Male
19 B5023	Water Hose Nipple
20 B5017	Water Outlet Hose O/Braid
21 B5022	Gun Plug Housing c/w Lock Nut and Hose Supports
22 B1526	Gun Plug Screw
23 B1519	Gun Plug Nut c/w Insert
24 Spring Pin 2	Spring Pin Assembly
25 B5098	Gun Plug Body c/w Spring Pins
26 B1524	Gun Plug 'O' Ring
27 B1525	Liner Nut

# PP 360A

## Air Cooled MIG Welding Torch

300A CO<sub>2</sub>, 270A Mixed Gas @ 60% Duty Cycle, EN60974-7 .030"- .045"/0.8mm to 1.2mm Wires

Coming Soon



New model available 2017

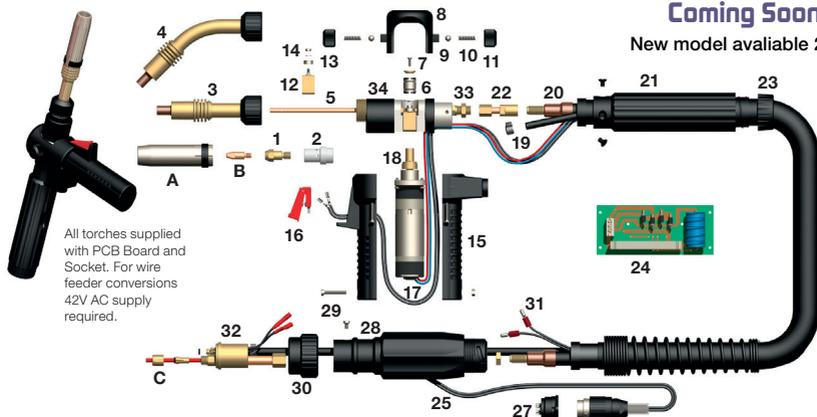

All torches supplied with PCB Board and Socket. For wire feeder conversions 42V AC supply required.

BZL

Models	Components
--------	------------

Stock Code	Description
PP3600A-80	Push Pull Welding Torch 180° Neck x 8m Euro
PP3645A-80	Push Pull Welding Torch 45° Neck x 8m Euro

Nozzles	
Stock Code	Description
A B3615	Cylindrical Nozzle 3/4"/19mm Bore
B3616*	Conical Nozzle 5/8"/16mm Bore
B3617	Tapered Nozzle 15/32"/12mm Bore

Contact Tips	
Stock Code	Description
B B2504-09	Contact Tip .035"/0.9mm M6 ECu
B2504-10	Contact Tip .040"/1.0mm M6 ECu
B2504-12*	Contact Tip .045"/1.2mm M6 ECu

Liners	
Stock Code	Description
C B1536-80	Teflon Liner .035"- .040"/0.6mm-0.9mm x 8m
B2513-80	Teflon Liner .040"- .045"/1.0mm-1.2mm x 8m
B3626-80	Teflon Liner .045"-1/16"/1.2mm-1.6mm x 8m

Components	
Stock Code	Description
1 B3612	Tip Adaptor 1.12"/28.5mm M6
2 B3605B	Diffuser Black
B3605C	Diffuser Ceramic
B3605W*	Diffuser White
3 B3638	Straight Neck
4 B3638-45	Swan Neck 45°
5 B3662	Contact Tube
6 B3656-08	Drive Roll 0.8mm
B3656-08A	Drive Roll 0.8mm Aluminium

B3656-10	Drive Roll 1.0mm
B3656-10A	Drive Roll 1.0mm Aluminium
B3656-12	Drive Roll 1.2mm
B3656-12A*	Drive Roll 1.2mm Aluminium
B3656-16	Drive Roll 1.6mm
B3656-16A	Drive Roll 1.6mm Aluminium
7 B3649	Assorted Screw & Nut Pack
8 B3644	Snap On Head
9 B3645	Ball Bearing
10 B3646	Spring
11 B3647	Spring Cap
12 B3640	Pressure Arm
13 B3641	Pressure Roll
14 B3657	Retaining Washer
15 B3648T	Pair Of Handles
16 B1408/PP	Blade Switch Trigger
17 B3654	Motor 42V
18 B3655	Seating
19 B5013-80	Gas Hose Assembly x 8m
20 B3673	Power Cable Assembly x 8m
21 B3661	Cable Support
22 B3675	Power Cable Adaptor
23 B5035	Cable Support Nut
24 B3667	Printed Circuit Board 42 Volt
25 B3663-85	Control Cable Assembly x 8m
26 B3674	5 Pin Tuchel Plug
27 B3672	Socket For Push Pull Plug
28 B5022/BK	Gun Plug Housing
29 B1526	Gun Plug Screw
30 B1519/BK	Gun Plug Nut-Black
31 B1523	Gun Plug Terminal
32 B3666	Gun Plug Body
33 B3642	Inlet Guide
34 B3639	Torch Body

\* Denotes Standard Build

# PP 400W

## Water Cooled MIG Welding Torch

400A CO<sub>2</sub>, 350A Mixed Gas @ 100% Duty Cycle, EN60974-7 .030"-.045"/0.8mm to 1.2mm Wires

Coming Soon 

New model available 2017

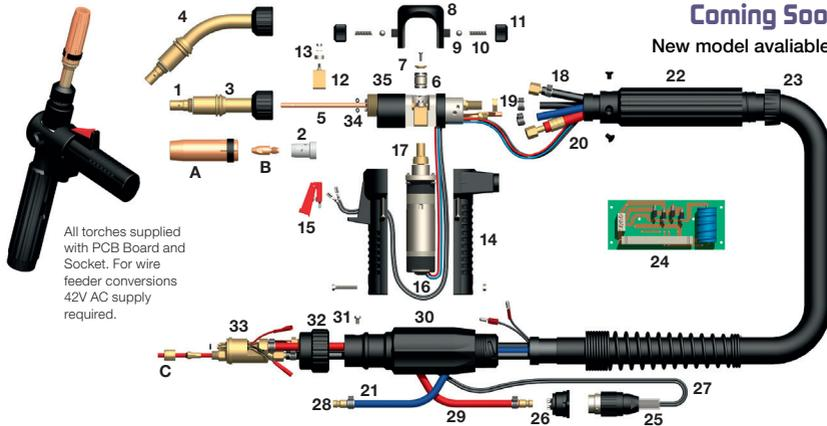

### Models

Stock Code	Description
PP400W-80	Push Pull Torch 180° Neck x 8m Euro
PP4045W-80	Push Pull Torch 45° Neck x 8m Euro

### Nozzles

Stock Code	Description
A B5027	Cylindrical Nozzle 3/4"/19mm Bore
B5028*	Conical Nozzle 5/8"/16mm Bore
B5029	Tapered Nozzle 9/16"/14mm Bore

### Contact Tips

Stock Code	Description
B B4014-10	Contact Tip .040"/1.0mm M8 ECU
B4014-12*	Contact Tip .045"/1.2mm M8 ECU
B4014-16	Contact Tip 1/16"/1.6mm M8 ECU

### Liners

Stock Code	Description
C B2513-80	Teflon Liner .040"-.045"/1.0mm-1.2mm x 8m
B3626-80	Teflon Liner .045"-1/16"/1.2mm-1.6mm x 8m

### Components

Stock Code	Description
1 B5001	Tip Adaptor 1"/25mm M8
2 B5005B	Diffuser Black
2 B5005C	Diffuser Ceramic
3 B4051	Straight Neck
4 B4051-45	Swan Neck
5 B3662	Contact Tube
6 B3656-10	Drive Roll 1.0mm
B3656-10A	Drive Roll 1.0mm Aluminium
B3656-12	Drive Roll 1.2mm
B3656-12A*	Drive Roll 1.2mm Aluminium

### Components

\* Denotes Standard Build

Stock Code	Description
B3657	Retaining Washer
7 B3649	Assorted Screw & Nut Pack
8 B3644	Snap On Head
9 B3645	Ball Bearing
10 B3646	Spring
11 B3647	Spring Cap
12 B3640	Pressure Arm
13 B3641	Pressure Roll
14 B3648T	Pair Of Handles
15 B1408/PP	Blade Switch Trigger
16 B3654	Motor 42V
17 B3655	Seating
18 B5008-80	Outer Liner Assembly x 8m
19 B5013-80	Gas Hose Assembly x 8m
20 B4048-80	Power Cable Assembly x 8m
21 B5012-80	Water Inlet Hose Assembly x 8m
22 B3661	Cable Support
23 B5035	Cable Support Nut
24 B3667	Printed Circuit Board 42 Volt
25 B3674	5 Pin Tuchel Plug
26 B3672	Socket For Push Pull Plug
27 B3663-85	Control Cable Assembly x 8m
28 B5023	Water Hose Nipple
29 B5017	Water Outlet Hose O/Braid
30 B5022/BK	Gun Plug Housing
31 B1526	Gun Plug Screw
32 B1519/BK	Gun Plug Nut-Black
33 B5098	Gun Plug Body c/w Spring Pins
34 B2518	Teflon Liner 'O' Ring
35 B4046	Torch Body