



# INSTRUCTIONS FOR: GARAGE VACUUM 1500W WITH REMOTE CONTROL - WALL MOUNTING MODEL No: **GV180WM**

Thank you for purchasing a Sealey product. Manufactured to a high standard this product will, if used according to these instructions and properly maintained, give you years of trouble free performance.



**IMPORTANT: PLEASE READ THESE INSTRUCTIONS CAREFULLY. NOTE THE SAFE OPERATIONAL REQUIREMENTS, WARNINGS, AND CAUTIONS. USE THIS PRODUCT CORRECTLY, AND WITH CARE FOR THE PURPOSE FOR WHICH IT IS INTENDED. FAILURE TO DO SO MAY CAUSE DAMAGE AND/OR PERSONAL INJURY AND WILL INVALIDATE THE WARRANTY.**

## 1. SAFETY INSTRUCTIONS

### 1.1 ELECTRICAL SAFETY

❑ **WARNING!** It is the responsibility of the owner and the operator to read, understand and comply with the following:

You must check all electrical products, before use, to ensure that they are safe. You must inspect power cables, plugs, sockets and any other connectors for wear or damage. You must ensure that the risk of electric shock is minimised by the installation of appropriate safety devices. A Residual Current Circuit Breaker (RCCB) should be incorporated in the main distribution board. We also recommend that a Residual Current Device (RCD) is used. It is particularly important to use an RCD with portable products that are plugged into a supply which is not protected by an RCCB. If in any doubt consult a qualified electrician. You may obtain a Residual Current Device by contacting your Sealey dealer.

**You must also read and understand the following instructions concerning electrical safety.**

- 1.1.1 The **Electricity at Work Act 1989** requires that all portable electrical appliances, if used on business premises, are tested by a qualified electrician, using a Portable Appliance Tester (PAT), at least once a year.
- 1.1.2 The **Health & Safety at Work Act 1974** makes owners of electrical appliances responsible for the safe condition of those appliances and the safety of the appliance operators. **If in any doubt about electrical safety, contact a qualified electrician.**
- 1.1.3 Ensure that the insulation on all cables and on the appliance is safe before connecting it to the power supply. See 1.1.1. and 1.1.2. and use a Portable Appliance Tester.
- 1.1.4 Ensure that cables are always protected against short circuit and overload.
- 1.1.5 Regularly inspect power supply cables and plugs for wear or damage and check all connections to ensure that none are loose.
- 1.1.6 **Important:** Ensure that the voltage marked on the appliance matches the power supply to be used and that the plug is fitted with the correct fuse - see fuse rating at right.
- 1.1.7 **DO NOT** pull or carry the appliance by the power cable.
- 1.1.8 **DO NOT** pull the plug from the socket by the cable.
- 1.1.9 **DO NOT** use worn or damaged cables, plugs or connectors. Immediately have any faulty item repaired or replaced by a qualified electrician. When a BS 1363/A UK 3 pin plug is damaged, cut the cable just above the plug and **dispose of the plug safely.**

- Fit a new plug according to the following instructions (UK only).
- a) Connect the **GREEN/YELLOW** earth wire to the earth terminal 'E'.
- b) Connect the **BROWN** live wire to the live terminal 'L'.
- c) Connect the **BLUE** neutral wire to the neutral terminal 'N'.
- d) **After wiring, check that there are no bare wires, that all wires have been correctly connected, that the cable outer insulation extends beyond the cable restraint and that the restraint is tight.**

Double insulated products, which are always marked with this symbol , are fitted with live (brown) and neutral (blue) wires only. To rewire, connect the wires as indicated above - **DO NOT** connect either wire to the earth terminal.

- 1.1.10 Products which require more than 13 amps are supplied without a plug. In this case you must contact a qualified electrician to ensure that a suitably rated supply is available. We recommend that you discuss the installation of an industrial round pin plug and socket with your electrician.
- 1.1.11 If an extension reel is used it should be fully unwound before connection. A reel with an RCD fitted is preferred since any appliance plugged into it will be protected. The cable core section is important and should be at least 1.5mm<sup>2</sup>, but to be absolutely sure that the capacity of the reel is suitable for this product and for others which may be used in the other output sockets, we recommend the use of 2.5mm<sup>2</sup> section cable.

### 1.2 GENERAL SAFETY

- ✓ Disconnect the cleaner from the power supply before servicing, changing accessories, or performing any maintenance.
- ✓ Use only genuine parts and accessories. Unauthorised parts and accessories may be dangerous and will invalidate your warranty.
- ✓ Maintain the cleaner in good condition. Use an authorised agent for servicing. Keep machine clean, but **DO NOT** use solvents.
- ✓ For dry vacuuming ensure the cartridge filter is firmly in place before operating the cleaner.
- x **DO NOT** operate the unit without the cartridge filter in place (except when wet vacuuming). **Using the cleaner without a cartridge filter may cause damage to the vacuum cleaner and will invalidate your warranty.**
- ✓ Wear protective clothing and gloves.
- x **DO NOT** allow children or untrained persons to operate the cleaner.
- x **DO NOT** place attachments close to your face (especially eyes, ears, etc). **DO NOT** point the hose end at other persons or animals.
- ▲ **DANGER! DO NOT** vacuum hot or glowing ash, cigarette ends, inflammable, explosive, corrosive or other dangerous substances.
- x **DO NOT** operate the unit without the dust bag or optional cartridge filter (except when wet vacuuming).
- x **DO NOT** leave machine running unattended. Turn power supply OFF, and **DO NOT** leave the vicinity until motor has come to a complete stop.
- x **DO NOT** operate the cleaner while under the influence of drugs, alcohol or impairing medication, or if you are tired.
- x **DO NOT** use the cleaner in the rain or in very damp conditions.
- x **DO NOT** use the cleaner for a task it is not designed to perform.
- ✓ When not in use, store the cleaner in a safe, dry, childproof location.

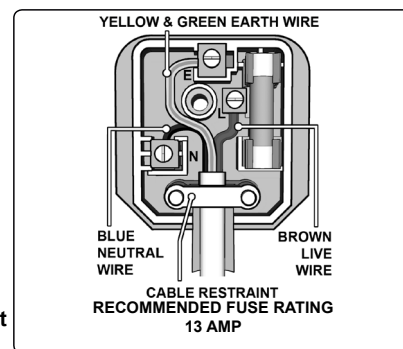

## 2. SPECIFICATION AND CONTENTS

Robust, wall mounting, remote control, wet and dry vacuum cleaner. Fitted with a powerful 1500W motor and noise diffuser, this unit is ideal for garage/workshop environments. Features an 8mtr spring hose ideal for double garages. Also features remote control buttons on the nozzle to allow the user to turn the unit on/off without leaving the cleaning area. Includes 5mtr power cable, extension lances (x2), combo brush, round brush, deluxe car nozzle, crevice tool, washable cartridge filter, foam filter and dust bag. Innovative design allows these accessories to be stored away keeping your work area clean and tidy.

### 2.1 Carton content

- 2.1.1 Carefully unpack the carton.
- 2.1.2 Locate the two side clasps which hold the power head (fig.2) in place.
- 2.1.3 Undo the clasps, remove the power head and take out the items in the container.
- 2.1.4 Check and identify each component as listed below. If anything is missing or damaged please contact your supplier immediately.

Item	Description	
A.....	Hose Holding Rack	K.....
B.....	Steel Mounting Rod	L.....
C.....	Mounting Rack	M.....
D.....	Wire Accessory Rack	N.....
E.....	Vacuum Assembly	O.....
F.....	Standard Hose	P.....
G.....	Flex Hose	Q.....
H.....	Extension Wands	R.....
I.....	Car Nozzle	S.....
J.....	Combo Brush	T.....
		Crevice Tool
		Round Brush
		Suction Control Handle
		Air/Noise Diffuser
		Cartridge Filter
		Filter Retainer
		Foam Filter
		Dust Collection Bag
		Screws
		Expansion Bolts

### 2.2 Specification

Model No:	GV180WM
Motor Power:	1500W
Supply:	230V
Maximum Vacuum Pressure:	165mbar
Air Flow:	71.28m <sup>3</sup> /hr
Drum Size:	18ltr
Weight:	7kg
Vac Accessories Ø:	35mm
Filter Type:	Cartridge
Replacement Locking Cartridge Filter:	GV180WM.27
Replacement Foam Filters:	GV180WM.26
Optional Dust Bags:	GV180WM.18

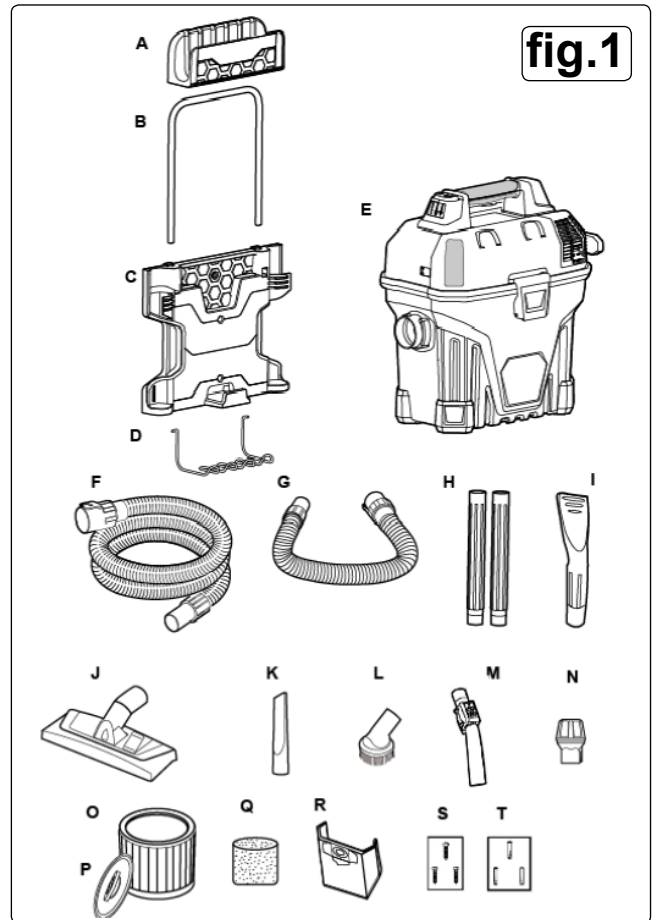
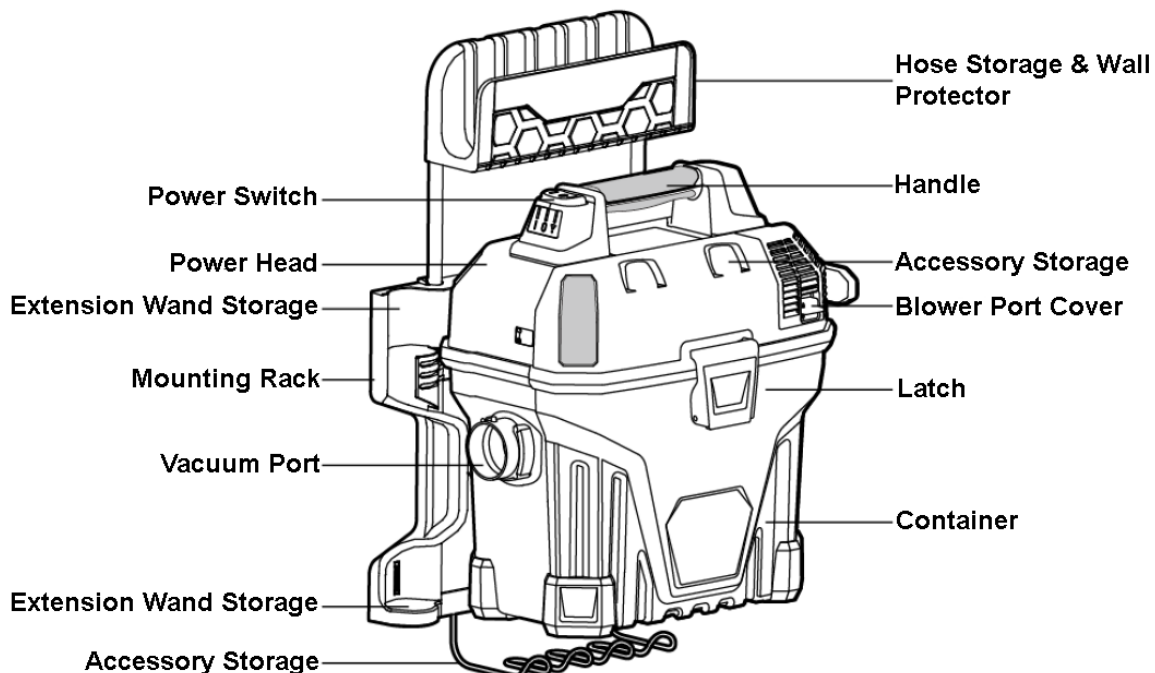

fig.1

fig.2



### 3. ASSEMBLY

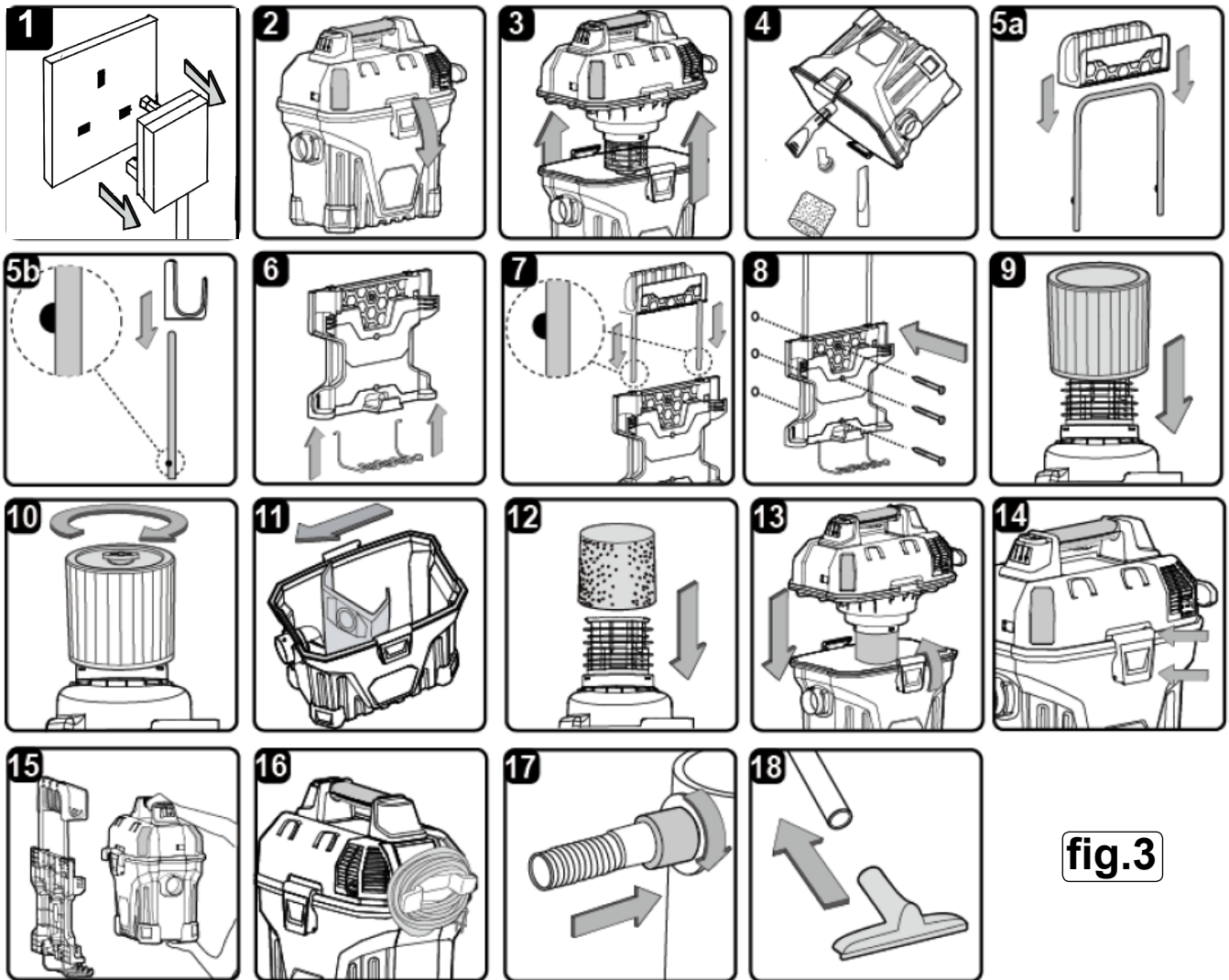

fig.3

❑ **WARNING! DO NOT** plug in the power cord to the power outlet. Make sure the plug is disconnected before assembling the vacuum.

#### 3.1. MOUNTING RACK AND STORAGE ASSEMBLY

- 3.1.1. **DO NOT** mount the rack more than 1.5mtr from the floor.
- 3.1.2. Mount the vacuum into brick or the studwork of a dry wall.
- 3.1.3. **DO NOT** hang from or sit on the mounting rack.
- 3.1.4. **DO NOT** exceed the 18.16kg maximum weight.
- 3.1.5. Insert the steel rod into the hose holding rack (fig.3.5a & fig.3.5b) and snap into place. Make sure the buttons on the rod are facing towards you.
- 3.1.6. Locate the two openings on the bottom of the mounting and insert the wire accessory storage into the mounting rack until they lock into place. Make sure the wire accessory storage is directed towards the front of the mounting rack. (Fig.3.6).
- 3.1.7. Insert the steel rod of the hose holding rack into the two holes located on the top of the mounting rack. (Fig.3.7).
- 3.1.8. Choose a wall that is not more than 5.5mtr away from an electrical outlet. Use the Mounting Rack Hole Template (see section 9) to align the three screw holes into a sound wall. Make sure it is level, drill 3mm pilot holes and secure the rack onto the wall using the three screws provided. (Fig.3.8).

#### 3.2. MOUNTING THE VACUUM ONTO THE RACK

- 3.2.1. The vacuum comes ready for dry vacuum cleaning. If the cartridge filter is not installed refer to 7.2. (Fig.3.9 & Fig.3.10).
- 3.2.2. For improved dust filtering fit the dust collection bag flange onto the inlet stub, taking care not to damage the bag. (Fig.3.11).
- 3.2.3. For wet vacuuming install the supplied foam filter. (Fig.3.12) See 7.4 for filter installation.
- 3.2.4. Place the power head onto the container, and secure with the two side latches. (Fig. 3.13 & 3.14).
- 3.2.5. Mount the vacuum onto the mounting rack by aligning the vacuum hanging hook on the rear, with the slot on the mounting rack and slide downwards until it locks. (See 3.15).
- 3.2.6. Wind the excess power cord around the cord wrap hooks located on the side of the vacuum. (Fig.3.16).
- 3.2.7. Insert the locking end of the hose into the vacuum port and lock it into place. (Fig.3.17).
- 3.2.8. Secure an accessory onto the end of the hose.

❑ **WARNING! DO NOT** vacuum drywall dust, soot or ash. This is very fine dust which will not be captured by the filter and may cause damage to the motor and void the warranty.

#### 3.3. REMOVING THE VACUUM FROM THE RACK

- 3.3.1. Disconnect the power cord from the electrical outlet.
- 3.3.2. Lift the vacuum up and out of the rack by its handle.

## 4. DRY VACUUM CLEANING

**WARNING! DO NOT** vacuum in areas with flammable gases, vapours or explosive dusts in the air. Flammable gases include, but are not limited to: lighter fluid, solvent type cleaners, oil based paints, gasoline, alcohol or aerosol sprays. Explosive dusts include, but are not limited to: coal, magnesium, grain or gun powder. To reduce the risk of health hazards from vapours or dust, **DO NOT** vacuum toxic materials.

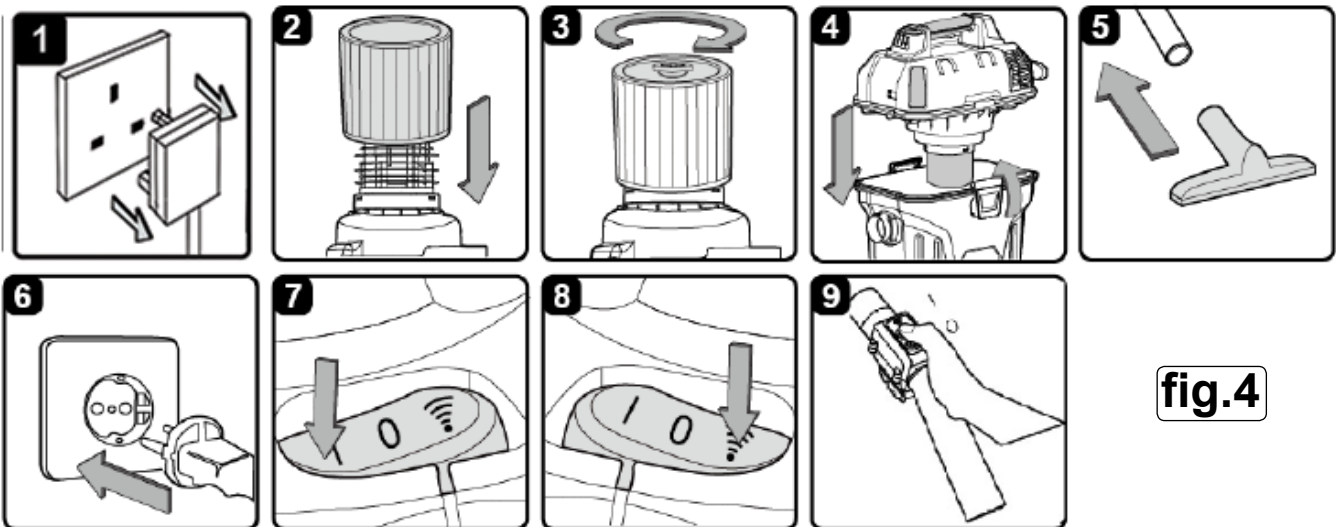



fig.4

### 4.1. BEFORE DRY VACUUMING

- 4.1.1. Make sure the power cord is disconnected from the outlet. (Fig.4.1 & 4.1.2). Verify that the cartridge filter is securely mounted. Make sure that the filter is pushed in until it stops against the power head. (Fig.4.2).
- 4.1.3. Place the filter retainer on top of the cartridge filter and tighten by turning the retainer handle clockwise. (Fig.4.3).
- 4.1.4. Place the power head back on the container, aligning the top section with the latches, and lock it into place. (Fig.4.4).

### 4.2. DRY VACUUMING

- 4.2.1. Insert the locking end of the hose into the vacuum port and lock in place. Push the required attachment onto the free end of the hose or extension. (Fig.4.5).
- 4.2.2. Plug power cord into the outlet and hang the vacuum on the rack or use off the rack. (Fig.4.6).
- 4.2.3. Turn the motor on by flipping the switch to the 'I' ON position. (Fig.4.7). For remote control use, set the power switch to remote control position  and turn the vacuum on by pressing the 'I' ON button on the remote control. (Figs 4.8 & 4.9).
- 4.2.4. Once you have finished vacuuming, flip the switch to the 'O' OFF position or press the 'O' OFF button on the remote control for at least one second.

## 5. WET VACUUM CLEANING

- WARNING! DO NOT** use the cartridge filter for wet vacuuming.
- WARNING! DO NOT** plug in the power cord to the power outlet. Make sure the plug is disconnected before assembling the unit for wet or dry use.
- WARNING!** When vacuuming large quantities of liquids, remove the vacuum from the mounting rack and put it on the floor. The vacuum can be heavy when full of liquids and may be difficult to remove from the rack.

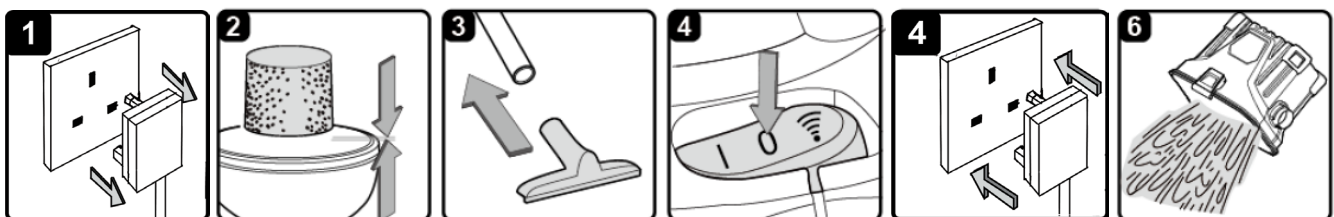

fig.5

### 5.1. BEFORE WET VACUUMING

- 5.1.1. Check that the power cord is disconnected from the outlet. (Fig.5.1)
- 5.1.2. Check that the container is clean and free of dust and dirt.
- 5.1.3. Remove cartridge filter and dust collection bag, then carefully install the foam filter over the filter cage and place the power head back on the container. (Fig.5.2) See filter installation instructions 7.4.

**X DO NOT** use the cartridge filter or dust collection bag for liquid vacuuming.

### 5.2. WET VACUUMING

- 5.2.1. Fit the desired nozzle to the vacuum hose. (Fig.5.3).
- 5.2.2. Check that the switch is in the 'O' OFF position before plugging the power cord into the outlet. (Fig.5.4 & 5.5)
- 5.2.3. Turn the motor on by flipping the switch on the power head to the 'I' ON position or flip the switch on the remote control position and use the 'I' ON button on the remote control.

**WARNING! DO NOT** submerge the remote control in liquids.

- 5.2.4. After wet vacuuming turn the machine off and remove plug from the power supply. To prevent the risk of mildew, empty the container, clean and dry the inside and outside of the container, remove the foam filter and allow to dry before storage. (Fig.5.6).

**IMPORTANT:** When vacuuming large quantities of liquids, **DO NOT** immerse the nozzle completely in the liquid; leave a gap at the tip of the nozzle to allow air inflow. The machine is fitted with a float valve that stops the suction action when the container reaches its maximum capacity. You will notice an increase in motor speed. When this happens, turn off the machine, disconnect from the power supply and empty the container into a suitable receptacle or drain. To continue vacuuming, refit the power head to the container. After wet vacuuming, turn the machine off and remove from the power supply. To prevent the risk of possible mildew refer to 5.2.4.

**IMPORTANT:** The foam filter must be removed after wet vacuuming and a cartridge filter must be installed before dry vacuuming again.



## 6. BLOWING

fig.6

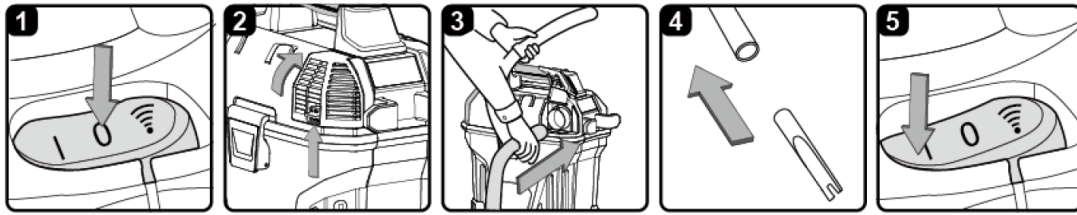

- WARNING!** Always wear safety goggles before using the blower.
- WARNING!** Keep bystanders away from blowing debris.
- WARNING!** Wear a dust mask if blowing creates dust that might be inhaled.

6.1. Make sure the vacuum is switched off. (Fig.6.1).

6.1.1. Make sure the container is empty before using it as a blower.

6.1.3. Lift the blower filter door button to the unlocked position and flip the blower filter door open. (Fig.6.2).

6.1.4. Remove the hose from the vacuum port and insert the locking end of the hose into the blowing port on the power head and lock into position. (Fig.6.3).

6.1.5. Fit the desired extension wand and/or nozzle to the free end of the vacuum hose. (Fig.6.4).

6.1.6. Before turning ON the vacuum, firmly hold the loose end of the hose. Turn the motor on by flipping the switch to the 'I' ON position or use the vacuum with the switch set to remote control. (Fig.6.5)

## 7. MAINTENANCE

fig.7

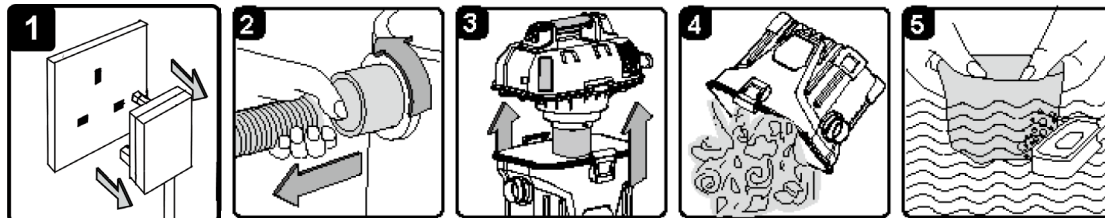

7.1. Make sure the power cord is disconnected from the outlet. (Fig.7.1)

7.1.1. Disconnect the hose from the vacuum. (Fig.7.2)

7.1.2. Remove the vacuum from the mounting rack.

7.1.3. Undo the latches and remove the power head from the container. (Fig.7.3)

7.1.4. Clear out all dirt or debris from the container and the hose. (Fig.7.4)

7.1.5. Clean the foam filter by washing it with water and mild soap. (Fig.7.5)

7.1.6. Check the hose, attachments and power cord to check that they have not been damaged.

**IMPORTANT:** Clean or change the cartridge filter regularly for best performance. **ALWAYS USE CARTRIDGE FILTER FOR DRY VACUUMING.** If the machine is used without the cartridge filter, the motor will burn out and the warranty will be voided. Always keep spare filters on hand.

**IMPORTANT:** The filters are made of high quality materials designed to stop small dust particles. The cartridge filter and dust collection bag should be used for dry pick-up only. A dry cartridge filter is necessary to pick up dust. If the cartridge filter is wet, it will clog quickly and be difficult to clean. Handle the filter carefully when removing it for cleaning or replacing. Check the filters for tears or small holes. A small hole can let dust pass through and out of the cleaner. Do not use a filter with holes or tears, replace it immediately.

- WARNING!** Always disconnect the plug from the power outlet before removing the power head from the container.

### 7.2 INSTALLING THE CARTRIDGE FILTER

fig.8

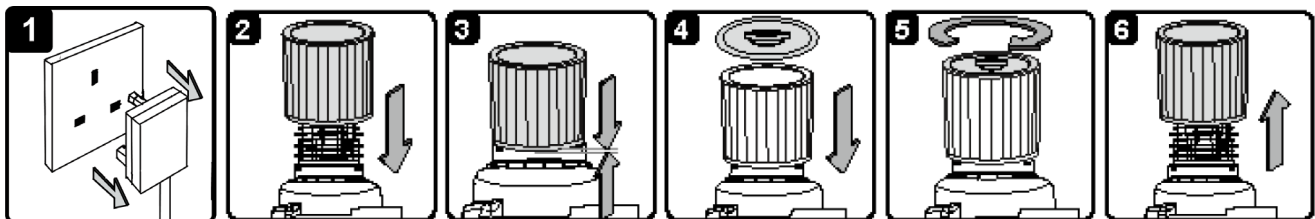

7.2.1. Make sure the power cord is disconnected from the outlet. (Fig.8.1).

7.2.2. Remove the power head and place upside down.

7.2.3. Install the cartridge filter over the filter cage with the flat end of the filter towards the vacuum power head. Carefully push filter in until it stops against the power head. (Fig. 8.2 & 8.3).

7.2.4. Place filter retainer on top of cartridge filter over the raised lip and tighten down by turning retainer clockwise. **DO NOT** overtighten. (Fig.8.4 & 8.5).

### 7.3 REMOVING AND CLEANING THE CARTRIDGE FILTER

7.3.1. Unlock and remove the filter retainer by turning the handle anticlockwise.

7.3.2. Carefully hold and pull the cartridge filter up for removal. (Fig.8.6).

7.3.3. Clean the cartridge filter by gently tapping or brushing dirt off. Cleaning should not be done indoors. For optimal performance a new filter is recommended.

7.3.4. Install cleaned filter, refer to 7.2.

#### 7.4. INSTALLING THE FOAM SLEEVE FILTER

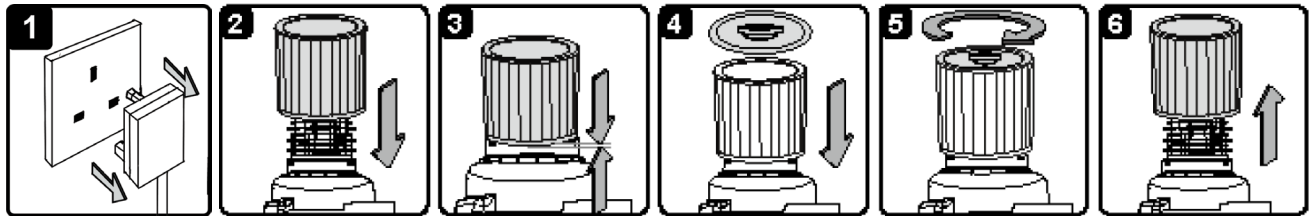

**fig.9**

- 7.4.1. Make sure the power cord is disconnected from the outlet. (Fig.9.1).
- 7.4.2. Remove the power head and place upside down. Follow instructions to remove cloth filter, refer to 7.3.
- 7.4.3. Carefully slide foam filter down over the filter cage, making sure the whole cage is covered. (Fig.9.2 & 9.3).
- 7.4.4. Replace the power head on the container.

#### 7.5. CLEANING THE FOAM SLEEVE FILTER

- 7.5.1. With the removed power head in the upside down position, carefully remove the foam filter. (Fig.9.4).
- 7.5.2. Use mild soap and water solution to wash foam filter and rinse again with clean water. (Fig.9.5).
- 7.5.3. Allow filter to air dry before installing and using again.

#### 7.6. RESETTING THE REMOTE CONTROL

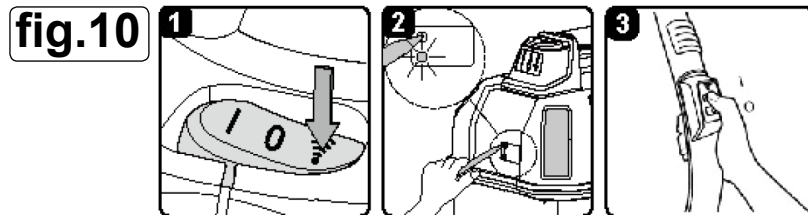

- 7.6.1. Have the remote control accessible. Set the power switch on the vacuum to remote control position (Fig.10.1).
- 7.6.2. Press the RESET button on the side of the power head with a pointed object such as a paper clip or a pen tip until the indicator lights up. (Fig.10.2).
- 7.6.3. Release the RESET button once the red indicator light lights up and immediately press and hold the 'ON' button on the remote control handle until the vacuum powers on. (Fig.10.3).
- 7.6.4. If the 'ON' button is not pressed and held within a 15 second window, the reset will not be successful. Repeat steps 7.6.2 and 7.6.3 to reset the remote control.

**IMPORTANT:** When the vacuum is not in use make sure the switch is in the 'O' OFF position and the power cord is disconnected.

## 8. TROUBLESHOOTING

Problem	Possible Causes	Corrective Action
Vacuum will not operate.	No power supply	Check power supply: cord, breakers, fuses
	Faulty power cord	Unplug and check the power cord. If damaged, have it repaired by a professional.
	Container full	Empty container.
	Switch in wrong position.	Press the ON 'I' button on the power head.
Dust comes from the motor cover.	The reuseable cloth filter is missing or damaged.	Attach or replace cartridge filter.
Reduced efficiency and motor speed/vibration.	Blockage in the nozzle, hose, or the vacuum inlets. Or the dust filter is blocked by fine dust.	Check nozzle, hose and container inlets for blockage. Take off the filter and clean it, or install a new cartridge filter.
Remote will not operate.	Battery is dead.	Replace the battery.

Parts support is available for this product. To obtain a parts listing and/or diagram, please log on to [www.sealey.co.uk](http://www.sealey.co.uk), email [sales@sealey.co.uk](mailto:sales@sealey.co.uk) or telephone 01284 757500.



#### Environmental Protection.

Recycle unwanted materials instead of disposing of them as waste. All tools, accessories and packaging should be sorted, taken to a recycle centre and disposed of in a manner which is compatible with the environment.



#### WEEE Regulations.

Dispose of this product at the end of its working life in compliance with the EU Directive on Waste Electrical and Electronic Equipment. When the product is no longer required, it must be disposed of in an environmentally protective way. Contact your local solid waste authority for recycling information.

**NOTE:** It is our policy to continually improve products and as such we reserve the right to alter data, specifications and component parts without prior notice.

**IMPORTANT:** No liability is accepted for incorrect use of this product.

**WARRANTY:** Guarantee is 12 months from purchase date, proof of which will be required for any claim.

**INFORMATION:** For a copy of our latest catalogue and promotions call us on 01284 757525 and leave your full name and address, including postcode.



Sole UK Distributor, Sealey Group,  
Kempson Way, Suffolk Business Park,  
Bury St. Edmunds, Suffolk,  
IP32 7AR



01284 757500



[www.sealey.co.uk](http://www.sealey.co.uk)



01284 703534



[sales@sealey.co.uk](mailto:sales@sealey.co.uk)

**9. MOUNTING RACK HOLE TEMPLATE**

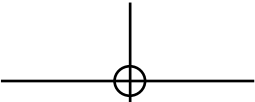

Drill top hole here



Drill middle hole here



Drill bottom hole here