

Thank you for purchasing a Sealey product. Manufactured to a high standard this product will, if used according to these instructions and properly maintained, give you years of trouble free performance.

**IMPORTANT: PLEASE READ THESE INSTRUCTIONS CAREFULLY. NOTE THE SAFE OPERATIONAL REQUIREMENTS, WARNINGS & CAUTIONS. USE THE PRODUCT CORRECTLY AND WITH CARE FOR THE PURPOSE FOR WHICH IT IS INTENDED. FAILURE TO DO SO MAY CAUSE DAMAGE AND/OR PERSONAL INJURY AND WILL INVALIDATE THE WARRANTY. PLEASE KEEP INSTRUCTIONS SAFE FOR FUTURE USE.**

## 1. SAFETY INSTRUCTIONS

### 1.1. ELECTRICAL SAFETY

**WARNING!** It is the user's responsibility to read, understand and comply with the following:

You must check all electrical equipment and appliances to ensure they are safe before using. You must inspect power supply leads, plugs and all electrical connections for wear and damage. You must ensure the risk of electric shock is minimised by the installation of appropriate safety devices. An RCCB (Residual Current Circuit Breaker) should be incorporated in the main distribution board. We also recommend that an RCD (Residual Current Device) is used with all electrical products. It is particularly important to use an RCD with portable products that are plugged into an electrical supply not protected by an RCCB. If in doubt consult a qualified electrician. You may obtain a Residual Current Device by contacting your Sealey dealer. **You must** also read and understand the following instructions concerning electrical safety.

1.1.1. The **Electricity At Work Act 1989** requires all portable electrical appliances, if used on business premises, to be tested by a qualified electrician, using a Portable Appliance Tester (PAT), at least once a year.

1.1.2. The **Health & Safety at Work Act 1974** makes owners of electrical appliances responsible for the safe condition of the appliance and the safety of the appliance operator. **If in doubt about electrical safety, contact a qualified electrician.**

1.1.3. Ensure the insulation on all cables and the product itself is safe before connecting to the mains power supply. See 1.1.1. & 1.1.2. above and use a Portable Appliance Tester (PAT).

1.1.4. Ensure that cables are always protected against short circuit and overload.

1.1.5. Regularly inspect power supply, leads, plugs for wear and damage and all electrical connections to ensure that none is loose.

1.1.6. **Important:** Ensure the voltage marked on the product is the same as the electrical power supply to be used and check that the plug is fitted with the correct capacity fuse. A 13 amp plug may require a fuse smaller than 13 amps for certain products, see fuse rating at right.

1.1.7. DO NOT pull or carry the powered appliance by its power supply lead.

1.1.8. DO NOT pull power plug from socket by the power cable.

1.1.9. DO NOT use worn or damaged leads, plugs or connections. Immediately replace or have repaired by a qualified electrician. A U.K. 3 pin plug with ASTA/BS approval is fitted. In case of damage, cut off and fit a new plug according to the following instructions (discard old plug safely).

(UK only - see diagram at right). **Ensure the unit is correctly earthed via a three-pin plug.**

a) **Connect the GREEN/YELLOW earth wire to the earth terminal 'E'.**

b) **Connect the BROWN live wire to live terminal 'L'.**

c) **Connect the BLUE neutral wire to the neutral terminal 'N'.**

d) **After wiring, check that there are no bare wires, that all wires have been correctly connected, that the cable outer insulation extends beyond the cable restraint and that the restraint is tight.**

Double insulated products are often fitted with live (BROWN) and neutral (BLUE) wires only. Double insulated products are always marked with this symbol . **To re-wire, connect the brown & blue wires as indicated above. DO NOT connect the brown or blue to the earth terminal.**

1.1.10. **Extension cable reels.** When an extension cable reel is used it should be fully unwound before connection. A cable reel with an RCD fitted is recommended since any product which is plugged into the cable reel will be protected. The section of the cores of the cable is important and should be at least 1.5mm<sup>2</sup>, but to be absolutely sure that the capacity of the cable reel is suitable for this product and for others that may be used in the other output sockets, we recommend the use of 2.5mm<sup>2</sup> section cable.

### 1.2. GENERAL SAFETY

✓ Familiarise yourself with the application, limitations and potential hazards of the lathe.

❑ **WARNING!** Disconnect the lathe from the mains power before changing accessories, servicing or performing any maintenance.

✓ Maintain the lathe in good condition (use an authorised service agent to service and maintain the motor).

✓ Replace or repair damaged parts. *Use genuine parts only. Unauthorised parts may be dangerous and will invalidate the warranty.*

❑ **WARNING!** Keep all guards and holding screws in place, tight and in good working order. Check regularly for damaged parts.

✓ Locate lathe in a suitable work area. Keep area clean and tidy, free from unrelated materials and ensure that there is adequate lighting.

✓ Keep the lathe clean for best and safest performance and check moving parts alignment regularly.

✓ Keep turning tools clean and sharp for best and safest performance.

✓ Ensure that there are no flammable or combustible materials near the work area.

❑ **WARNING!** Always wear approved eye or face protection when operating the lathe (standard spectacles are not adequate). Wear approved ear defenders and use a face or dust mask if dust is generated.

✓ Keep hands and body clear when operating the lathe. DO NOT reach across the lathe.

✓ Maintain correct balance and footing. Ensure the floor is not slippery and wear non-slip shoes.

✓ Remove ill fitting clothing. Remove ties, watches, rings and other loose jewellery and contain and/or tie back long hair.

✓ Keep children and unauthorised persons away from the work area.

✓ Remove all wrenches, hex keys etc. from the lathe and its vicinity before turning it on.

✓ Avoid unintentional starting and ensure the lathe power switch is "OFF" before plugging into the mains power supply.

x DO NOT use the lathe for a task that it is not designed to perform.

x DO NOT operate the lathe if any parts are damaged or missing, as this may cause failure and/or personal injury.

❑ **WARNING!** DO NOT use the lathe to cut any materials other than wood.

x DO NOT stand or climb on the lathe.

x DO NOT get the lathe wet or use in damp or wet locations or areas where there is condensation.

x DO NOT use any tools other than those appropriate to wood turning.

x DO NOT pull the plug from the power socket by the cable.

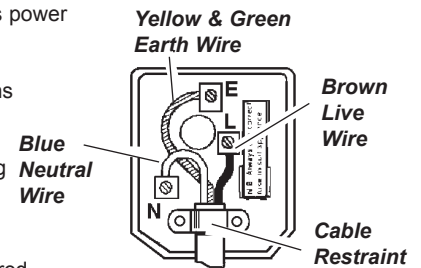

**FUSE RATING  
 THIS PRODUCT MUST  
 BE FITTED WITH A  
 13 AMP FUSE**

- ✓ When not in use switch off the lathe and remove the plug from the power socket.
- x DO NOT operate the lathe when you are tired or under the influence of alcohol, drugs or intoxicating medication.
- x DO NOT leave the lathe operating unattended and do not leave the work area until the lathe is at a complete stand still.

### 1.3. WOOD CUTTING SAFETY

- ✓ Remove all loose wood knots before mounting workpiece on the lathe.
- ✓ Fasten the workpiece securely to the faceplate or between centres before turning on the lathe. Wrong set-up procedures may cause the workpiece to be thrown from the lathe, which may cause personal injury.
- ✓ To confirm that the workpiece will not hit any part of the lathe always rotate it by hand before turning on the motor.
- ✓ Rough out a workpiece to be as true and round as possible before attaching to the faceplate. This will minimise vibration.
- ✓ Initially turn "out of round" workpieces at a slow speed. Running the lathe too fast will cause vibration, which may result in the workpiece being thrown from the lathe, or the tool to be pulled from your hand.
- ✓ Avoid awkward hand positions, care must be taken to stop your hands from slipping onto the rotating workpiece.
- ✓ Keep a firm control of the cutting tool. Care must be exercised when wood knots or voids are exposed to the turning tool.
- ✓ Complete any hand sanding before removing the workpiece from the lathe. Ensure that the lathe speed during sanding does not exceed the speed used for the last cutting operation performed on that same workpiece.
- x DO NOT store, or lay, work tools in such a way that you must reach over the lathe, or the workpiece, to select them. Hang or store the turning tools at the tail stock end of the lathe.
- x DO NOT allow the tool to "bite" into the workpiece as the wood may split, or be thrown from the lathe.
- ✓ For spindle turning, always position the tool rest above the centre line of the lathe. DO NOT apply the turning tool to the workpiece below the level of the rest itself.
- x DO NOT run the lathe in the wrong direction. This could cause the turning tool to be thrown from your hands. The workpiece surface must be moving downwards past the tool rest.
- ☐ **WARNING!** DO NOT remount a workpiece if the original centres of the workpiece have been altered or removed. Having remounted a workpiece where NO alteration has been made to the original centres, the lathe must be set to the lowest speed before turning it on.
- x DO NOT mount a workpiece that contains splits, checks or loose knots.
- x DO NOT switch on the lathe whilst the tool is in contact with the workpiece.
- ☐ **WARNING!** Keep alert. DO NOT allow familiarity (from frequent use) to cause a mistake. Remember, a careless second is sufficient to inflict serious damage and/or personal injury.

## 2. SPECIFICATION

Manufactured to comply with latest CE requirements, this economy lathe is ideal for the first time user. Powered by 370Watt motor with No-Volt load release switch which prevents re-start after the mains supply has been interrupted. Solid head and tail stocks. Lathe bed with twin bar construction. Four turning speed options to suit a variety of jobs. Fitted with a BS approved, non-rewirable 3 pin plug and cable.

Turning Capacity Over Bed . . . . . 350mm  
 Turning Capacity Over Tool Rest . . . . . 290mm  
 Thread Size (Headstock Spindle) . . . . . 3/4" x 16tpi  
 Distance Between Centres . . . . . 1000mm

Turning Speed Range . . . . . 850, 1250, 1750, 2510rpm  
 Motor . . . . . 370W - 230V/1ph

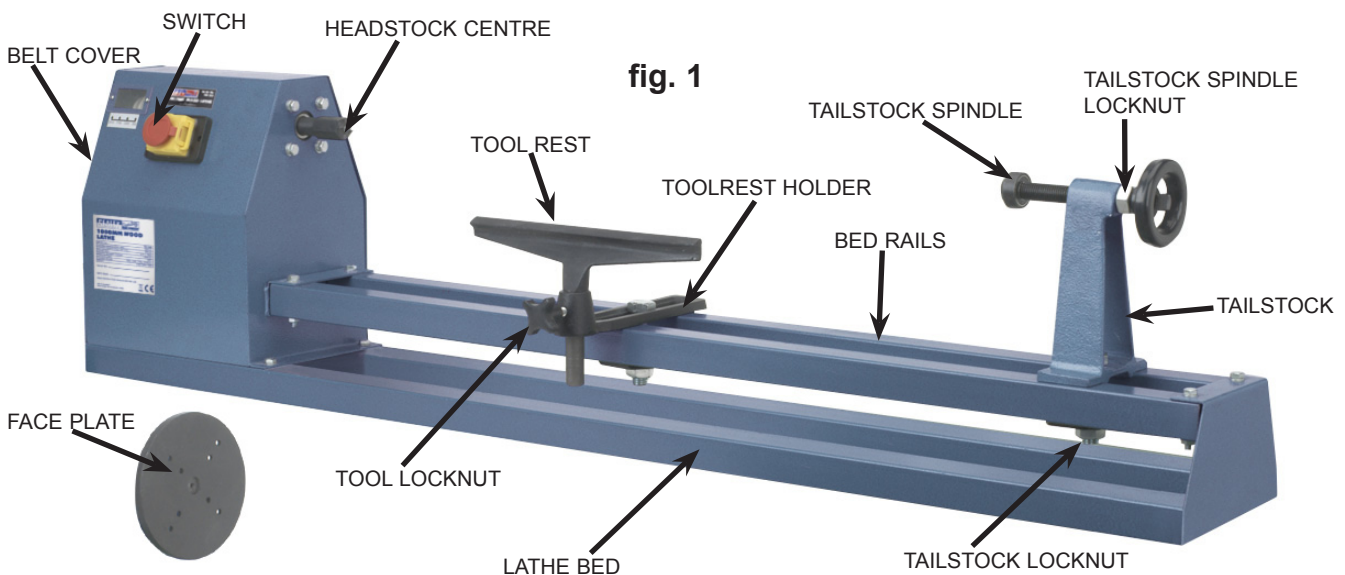

fig. 1

## 3. SETTING UP LATHE

### 3.1. Change Face Plate and Drive Centre

- 3.1.1. Unscrew the face plate (anticlockwise) while holding the headstock spindle using the spanner provided (Fig. 2).
- 3.1.2. Screw the headstock centre onto the spindle (Fig.1). Do not overtighten.

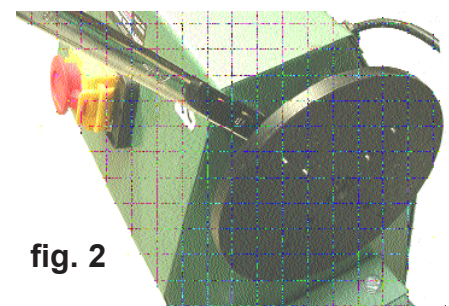

fig. 2

### 3.2. Tailstock (fig. 1 )

- 3.2.1. The tailstock may be moved along the lathe bed and the tailstock spindle adjusted to suit the workpiece length.
- 3.2.2. Loosen the tailstock locknut (Fig. 1), reposition the tailstock along the lathe bed and retighten the locknut.
- 3.2.3. To move the tailstock spindle loosen the spindle locknut and then turn the hand wheel as necessary. Retighten the locknut.

### 3.3. Speed control

☐ **WARNING! Ensure the power is disconnected.**

- 3.3.1. Remove the two cross head screws from the belt cover.
- 3.3.2. Loosen the two motor mounting bolts (Fig. 3).
- 3.3.3. Lift the lower pulley to slacken the belt and move the belt to the desired pulley steps.
- 3.3.4. Apply a downward pressure on the lower pulley to take up the slack on the belt and tighten the motor mounting bolts. For the correct belt tension, adjust the belt so there is 1/2" of movement at the mid position of the belt.

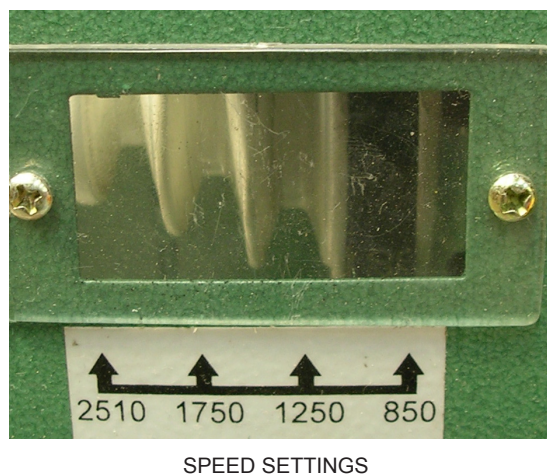
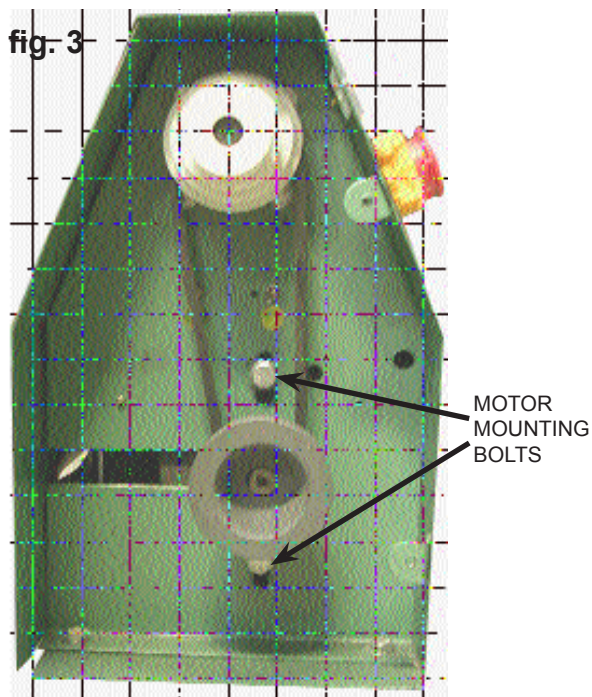

## 4. USING THE LATHE

☐ **WARNING! Ensure you read, understand and apply the safety instructions before using the lathe. If you have NO turning experience, we recommend you practice until you have familiarised yourself with the applications and limitations of the lathe and the hazards of turning.**

**DO NOT TAKE ANY CHANCES WHEN WORKING WITH A LATHE AND TURNING TOOLS.**

**Keep alert. DO NOT allow familiarity (from frequent use) to cause a careless mistake. Remember, failure to operate the lathe correctly is dangerous and may cause serious damage and/or personal injury.**

- 4.1. Fasten the workpiece securely to the faceplate or between centres. When screwing a workpiece to the faceplate use brass wood screws and check that the points of the screws will not foul the tool during turning.
- 4.2. Adjust the tool rest to suit, ensuring that it is close to the workpiece (we recommend a 3mm gap) and, for spindle turning, positioned above the centre line of the workpiece.
- 4.3. To confirm that the workpiece will not hit any part of the lathe always rotate it by hand before turning on the motor.
- 4.4. Check that all clamps and locks are tightened before switching on the lathe.

**Note: The lathe is fitted with a no-volt On/Off switch which automatically switches off if the supply is interrupted (power cut, socket switched off etc.) thereby preventing unexpected, and therefore dangerous, start-up when the supply is reconnected.**

- 4.5. To switch the lathe on open the switch cover and press the "I" button. Allow the cover to close but do not press fully shut and latched as this will switch off the lathe.
- 4.6. To switch the lathe off normally open the switch cover and press the "O" button. **In an emergency** push the red 'button' on the switch cover. This will stop the lathe and also latch the switch cover closed, with the "O" button depressed. The lathe cannot be restarted until the switch cover has been unlatched.
- 4.7. Switch lathe on and rough out "out-of-round" workpieces at a slow speed. Running the lathe too fast will cause vibration, which may result in the workpiece being thrown from the lathe, or the tool to be pulled from your hand.
- 4.8. Keep a firm control of the cutting tool. Care must be exercised when wood knots or voids in the workpiece are exposed.
- 4.9. Complete any hand sanding before removing the workpiece from the lathe. Ensure that the lathe speed during sanding does not exceed the last cutting speed used.

## 6. MAINTENANCE

☐ **WARNING! Ensure the lathe is unplugged from the mains power supply before service or maintenance.**

Keep the lathe clean and the surrounding area tidy.

Frequently blow out any dust accumulation in the motor, housing and bed. **Wear eye protection when doing so.**

Protect the bed from corrosion by occasionally applying automobile wax.

Regularly lightly oil control and clamp levers and threads to ensure smooth operation.

Should the motor require service or maintenance contact your local authorised service agent.

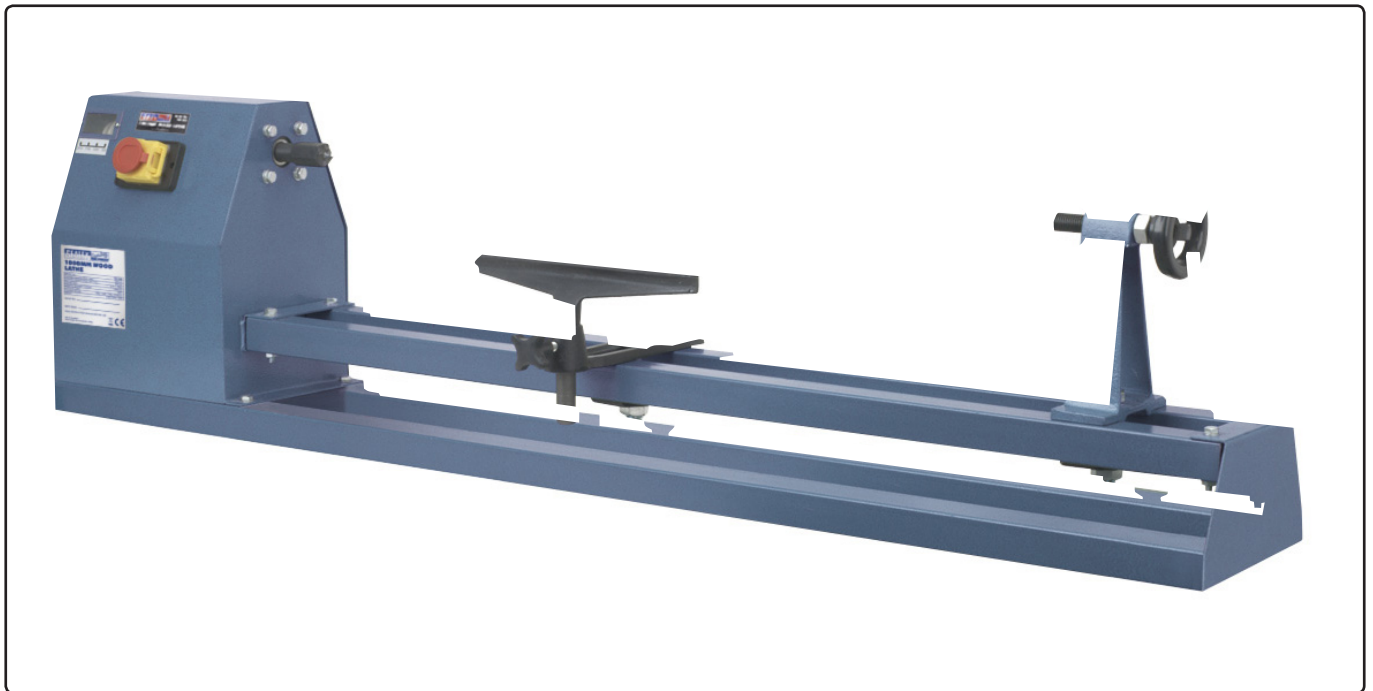

## 7. TROUBLESHOOTING

PROBLEM	POSSIBLE CAUSE	SOLUTION
Motor will not run	Defective On/Off switch or defective switch cable Motor burnt out	Replace defective parts.  DO NOT attempt to repair. Contact your local authorised service agent.
Lathe slows down when turning	Tools blunt Cut too deep	Sharpen tools. Reduce cut
Workpiece chars at tailstock end	Cup centre too tight or not lubricated	Back off tailstock spindle and lubricate cup centre.

**NOTE:** It is our policy to continually improve products and as such we reserve the right to alter data, specifications and component parts without prior notice.

**IMPORTANT:** No liability is accepted for incorrect use of this product.

**WARRANTY:** Guarantee is 12 months from purchase date, proof of which will be required for any claim.

**INFORMATION:** For a copy of our latest catalogue and promotions call us on 01284 757525 and leave your full name and address, including postcode.



Sole UK Distributor, Sealey Group,  
Kempson Way, Suffolk Business Park,  
Bury St. Edmunds, Suffolk,  
IP32 7AR



01284 757500

01284 703534



www.sealey.co.uk

sales@sealey.co.uk