



INSTRUCTIONS FOR:

## CUT-OFF MACHINE 355MM 230V WITH BLADE

MODEL No: **SM355B**

Thank you for purchasing a Sealey product. Manufactured to a high standard this product will, if used according to these instructions and properly maintained, give you years of trouble free performance.



**IMPORTANT: PLEASE READ THESE INSTRUCTIONS CAREFULLY. NOTE THE SAFE OPERATIONAL REQUIREMENTS, WARNINGS & CAUTIONS. USE THE PRODUCT CORRECTLY AND WITH CARE FOR THE PURPOSE FOR WHICH IT IS INTENDED. FAILURE TO DO SO MAY CAUSE DAMAGE AND/OR PERSONAL INJURY AND WILL INVALIDATE THE WARRANTY. PLEASE KEEP INSTRUCTIONS SAFE FOR FUTURE USE.**

### 1. SAFETY INSTRUCTIONS

#### 1.1. ELECTRICAL SAFETY

**WARNING!** It is the responsibility of the owner and the operator to read, understand and comply with the following: You must check all electrical products, before use, to ensure that they are safe. You must inspect power cables, plugs, sockets and any other connectors for wear or damage. You must ensure that the risk of electric shock is minimised by the installation of appropriate safety devices. A Residual Current Circuit Breaker (RCCB) should be incorporated in the main distribution board. We also recommend that a Residual Current Device (RCD) is used. It is particularly important to use an RCD with portable products that are plugged into a supply which is not protected by an RCCB. If in any doubt consult a qualified electrician. You may obtain a Residual Current Device by contacting your Sealey dealer.

**You must** also read and understand the following instructions concerning electrical safety.

- 1.1.1. The Electricity at Work Act 1989 requires that all portable electrical appliances, if used on business premises, are tested by a qualified electrician, using a Portable Appliance Tester (PAT), at least once a year.
- 1.1.2. The Health & Safety at Work Act 1974 makes owners of electrical appliances responsible for the safe condition of those appliances and the safety of the appliance operators. If in any doubt about electrical safety, contact a qualified electrician.
- 1.1.3. Ensure that the insulation on all cables and on the appliance is safe before connecting it to the power supply. See 1.1.1. and 1.1.2. and use a Portable Appliance Tester.
- 1.1.4. Ensure that cables are always protected against short circuit and overload.
- 1.1.5. Regularly inspect power supply cables and plugs for wear or damage and check all connections to ensure that none is loose.
- 1.1.6. Important: Ensure that the voltage marked on the appliance matches the power supply to be used and that the plug is fitted with the correct fuse - see fuse rating at right.
- 1.1.7. **DO NOT** pull or carry the appliance by the power cable.
- 1.1.8. **DO NOT** pull the plug from the socket by the cable.
- 1.1.9. **DO NOT** use worn or damaged cables, plugs or connectors. Immediately have any faulty item repaired or replaced by a qualified electrician. When a BS 1363/A UK 3 pin plug is damaged, cut the cable just above the plug and dispose of the plug safely.

Fit a new plug according to the following instructions (UK only).

- a) Connect the GREEN/YELLOW earth wire to the earth terminal 'E'.
- b) Connect the BROWN live wire to the live terminal 'L'.
- c) Connect the BLUE neutral wire to the neutral terminal 'N'.
- d) After wiring, check that there are no bare wires, that all wires have been correctly connected, that the cable outer insulation extends beyond the cable restraint and that the restraint is tight.

**Double insulated** products, which are always marked with this symbol , are fitted with live (brown) and neutral (blue) wires only.

To rewire, connect the wires as indicated above -

**DO NOT connect either wire to the earth terminal.**

- 1.1.10. Products which require more than 13 amps are supplied without a plug. In this case you must contact a qualified electrician to ensure that a suitably rated supply is available. We recommend that you discuss the installation of an industrial round pin plug and socket with your electrician.
- 1.1.11. If an extension reel is used it should be fully unwound before connection. A reel with an RCD fitted is preferred since any appliance plugged into it will be protected. The cable core section is important and should be at least 1.5mm<sup>2</sup>, but to be absolutely sure that the capacity of the reel is suitable for this product and for others which may be used in the other output sockets, we recommend the use of 2.5mm<sup>2</sup> section cable.

#### 1.2. GENERAL SAFETY

- WARNING!** Disconnect the cut-off machine from the mains power, and ensure that the cutting blade is at a complete standstill before attempting to change accessories, service or perform any maintenance.
- ✓ Maintain the cut-off machine in good condition (use an authorised service agent).
- ✓ Replace or repair damaged parts. Use recommended parts only. Unauthorised parts may be dangerous and will invalidate the warranty.
- ✓ Locate the cut-off machine in a suitable work area. Ensure that the surface is flat and firm. Keep the area clean and tidy and free from unrelated materials, and ensure that there is adequate lighting.
- ✓ Keep the cut-off machine clean for best and safest performance and check moving parts alignment regularly.
- WARNING!** Before each use check that the cutting blade is secure and that it is not worn or damaged.
- NOTE:** Only competent persons should attempt to change cutting blades.
- ✓ Ensure that replacement blades are not damaged in any way - cracks or deformations etc. Also check the mounting flanges to check that they are not deformed, burred or chipped. **DO NOT** over tighten a blade and never tamper with a blade in order to adapt it to a different size holder.
- ✓ Always use a blade suitable for the material being cut. Ensure that the cutting blade's specified maximum speed is equal to, or higher than, that indicated on the machine data plate. Once mounted on the cut-off machine, test the blade before use by facing the cut-off machine in a safe direction (point blade away from yourself, others and vulnerable items) and running it for a short time.
- WARNING!** Keep guard and holding screws in place, tight and in good working order. Check regularly for damaged parts. A guard or any other part that is damaged must be repaired or replaced before next use. The safety guard is a mandatory fitting when the cut-off machine is used on premises covered by the Health & Safety at Work Act.
- ✓ Remove adjusting keys and wrenches from the machine and its vicinity before turning it on.

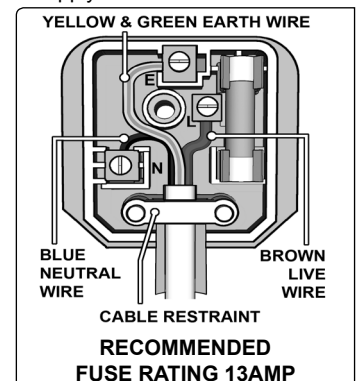

- ❑ **WARNING!** Wear approved safety eye protection, ear defenders, gauntlets and, if dust is generated, respiratory protection.
- ✓ Remove ill fitting clothing. Remove ties, watches, rings and other loose jewellery and contain long hair.
- ✓ Keep hands and body clear of the worktable when operating the cut-off machine, and **DO NOT** position your body in line with the blade.
- ✓ Maintain correct balance and footing. Ensure the floor is not slippery and wear non-slip shoes.
- ✓ Keep children and unauthorised persons away from the work area.
- ✓ Avoid subjecting blade to excessive strain, always ease blade down against workpiece (a harsh downward impact may break the blade). Do not apply undue force on the handle in order to cut workpiece. Maintain a controlled cutting speed through the workpiece.
- ❑ **WARNING! DO NOT** switch on the cut-off machine whilst the blade is in contact with the workpiece. Bring the rotating blade to the workpiece. Avoid un-intentional starting of the cut-off machine.
- x **DO NOT** hold the workpiece by hand. Use base vice to secure the workpiece.
- x **DO NOT** use the cut-off machine for a task it is not designed to perform.
- x **DO NOT** allow untrained persons to operate the cut-off machine.
- x **DO NOT** get the machine wet, or use in damp or wet locations or areas where there is condensation.
- ❑ **WARNING! DO NOT** use the cut-off machine where there are flammable liquids, solids or gases such as paint solvents and including waste wiping rags etc.
- x **DO NOT** operate the cut-off machine if any parts are missing or damaged as this may cause failure and/or personal injury.
- x **DO NOT** remove the safety guard whilst the cut-off machine is in use.
- x **DO NOT** attempt to remove a workpiece until the blade has stopped rotating.
- x **DO NOT** touch the workpiece close to the cut as it will be very hot. Allow to cool. The cut edge of the workpiece will also be very sharp.
- x **DO NOT** leave the cut-off machine operating unattended.
- x **DO NOT** operate the cut-off machine when you are tired or under the influence of alcohol, drugs or intoxicating medication.
- ✓ When not in use switch off the cut-off machine and remove the plug from the power supply.
- ✓ To move the cut-off machine, lock the machine head with the locking plate and lift by the handle.

## 2. APPLICATION & SPECIFICATIONS

Ø355mm TCT blade cuts slow and cold without the need for coolant fluid. Will handle steel, wood, brass, aluminium and most plastics, without the need to change blades. Even hidden nails/screws in timber are no longer a problem. Powered by a 2480W motor. Cast alloy base for added strength, while retaining portability. Features heavy-duty saw arm and quick action mitring vice. Fully guarded and fitted with a dead man's trigger control to prevent accidental starting. Supplied with BS fully approved 13Amp plug.

Size of blade: .....	Ø355mm	No load speed: .....	1450rpm
Blade: .....	SM355B72	Weight: .....	21kg
Max. cutting capacity @ 90°(bar):	Ø105mm	Noise power: .....	92.2dB(A)
Max. cutting capacity @ 90°(pipe):	Ø120mm	Noise Pressure: .....	105.9dB(A)
Max. cutting capacity @ 45°(bar):	Ø80mm	Vibration (load): .....	6.993m/s <sup>2</sup>
Cutting capacity @ 45°(pipe):	Ø95mm	Vibration (no load): .....	1.5m/s <sup>2</sup>
Motor: .....	2480W - 230V		

## 3. CONTENTS

Unpack the product and check the contents. Ensure that there is no damage. If any problem is noted, contact your supplier immediately.

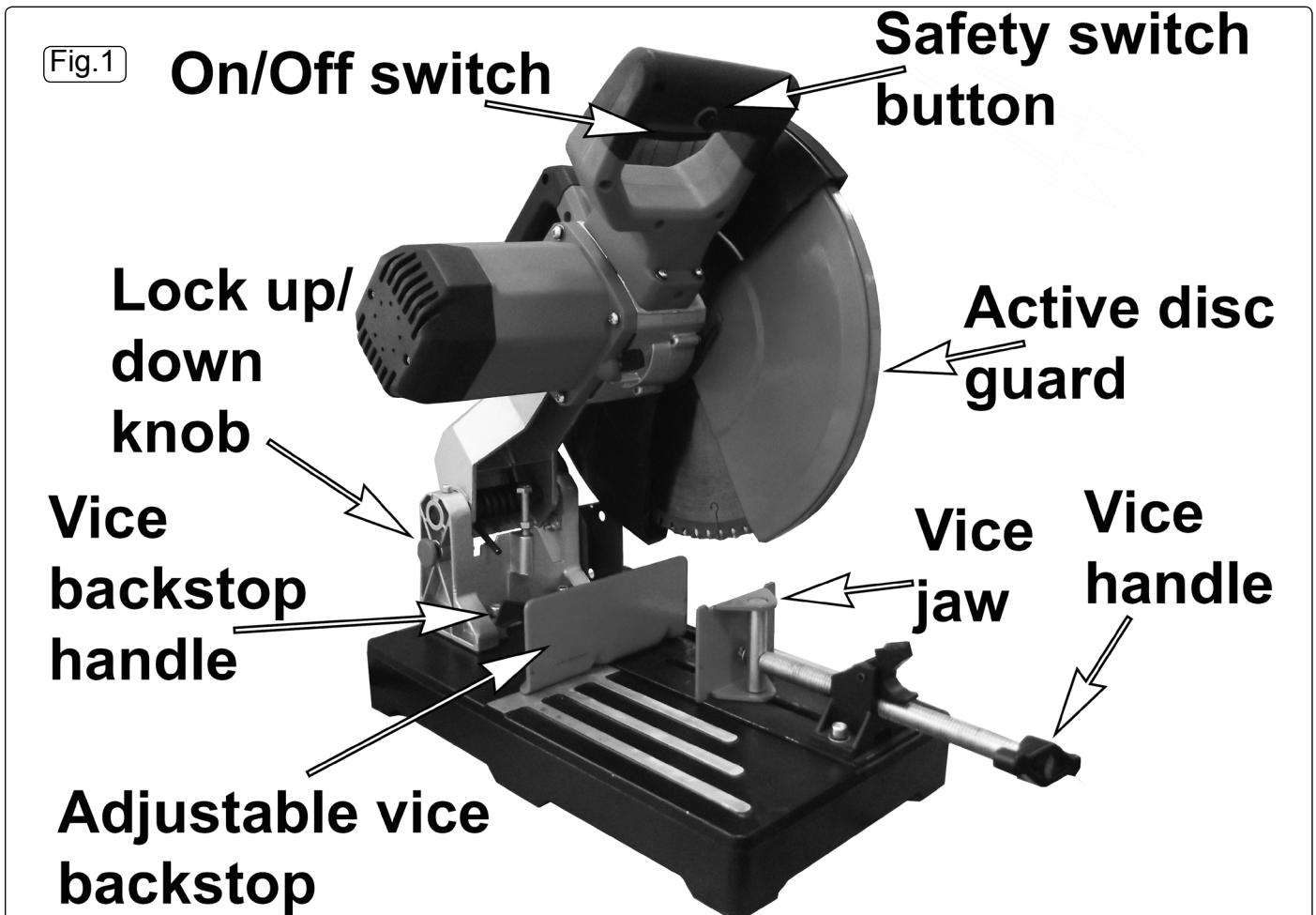

## 4. OPERATING INSTRUCTIONS

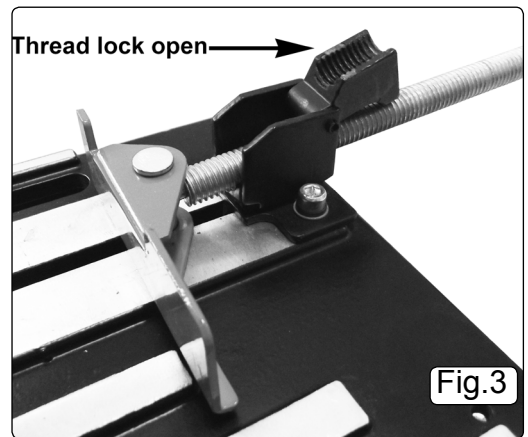
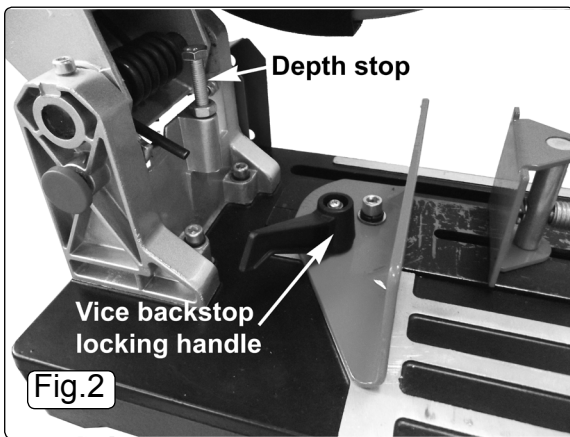

- ❑ **WARNING!** Before cutting ensure that you wear approved safety goggles, ear defenders, appropriate dust mask if cutting generates dust, and safety gloves. All safety instructions in Section 1 must be followed.

### 4.1. USING THE LOCKING KNOB. (Refer to Fig.1)

- 4.1.1. When not in use or when being transported the cutting arm should always be locked down. To lock the arm down, pull it to its lowest position against the return spring pressure until it is solidly against the stop. Firmly push the knob in. To release the arm, push it down slightly, pull out the knob and gently guide it back to its top position.

### 4.2. SECURING THE WORKPIECE.

#### 4.2.1. Ensure that the cut-off machine is unplugged from the power supply.

- 4.2.2. Check that the back stop is at 90° to the cutting blade using a set square.

Ensure the back stop fixings are tight using the hex key provided.

- 4.2.3. To move the other jaw up to the workpiece quickly, flip the thread lock open as shown in fig.3 and slide the jaw face up to the workpiece. Flip the thread lock back down and tighten the workpiece in the vice.

- 4.2.4. When cutting long workpieces use additional supports along the length.

### 4.3. CUTTING DEPTH

- 4.3.1. (See depth stop in fig.2). To adjust loosen the lock nut, adjust the stop using the hex key and retighten the lock nut. Only a small movement of the depth stop is required to increase/decrease the depth. There is a close relationship between the locking knob and the depth stop. After adjusting the depth stop check that the locking knob still functions correctly.

### 4.4. MITRE CUTTING

- 4.4.1. To cut at an angle loosen the vice backstop locking handle, by turning it anticlockwise. Lift the handle vertically and turn it clockwise to loosen the nut underneath if required. Align to the desired angle using the graduated scale on the base plate shown in fig.4, and retighten the vice backstop locking handle. Place the workpiece against the backstop and move the other jaw up to it, and securely tighten.

### 4.5. ON/OFF SWITCH

- 4.5.1. The On/Off switch is locked in the Off position. To turn on the saw you must press in the safety button with your thumb before pulling the switch upwards. The switch is spring loaded and must be held in the up position in order for the saw to continue running. As soon as the pressure on the switch is released the saw will turn off.

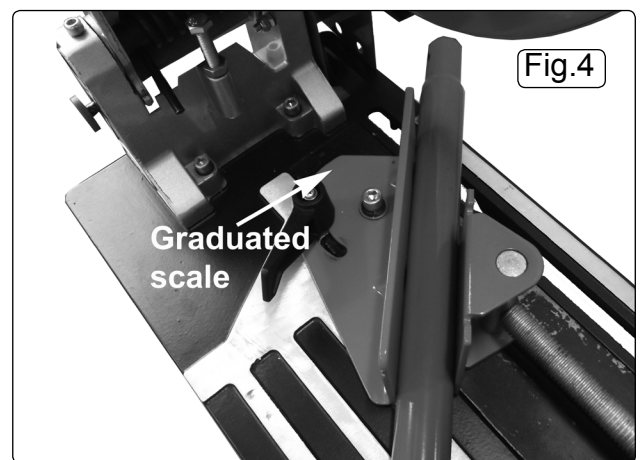

### 4.6. OPERATION

- ❑ **WARNING! DO NOT switch on the cut-off machine whilst the cutting blade is in contact with the workpiece. Bring the rotating blade to the workpiece.**

- 4.6.1. The cutting blade must be running at maximum speed before attempting to lower the cutting edge onto the workpiece.
- 4.6.2. Lower the cutting blade slowly and smoothly down towards the workpiece (avoid jerky movements).
- 4.6.3. Avoid subjecting the blade to excessive strain. Always ease the blade down against the workpiece (a harsh downward impact may cause blade failure) and do not apply undue force on the handle when cutting the workpiece. Maintain a controlled cutting speed.
- 4.6.4. When cutting is complete, fully raise the cutting blade and release the On/Off switch.
- 4.6.5. Wait until the blade has stopped rotating before attempting to remove the workpiece.

## 5. CHANGING CUTTING BLADE

- ▲ **DANGER!** The use of damaged blades is dangerous and may cause injury.
- ☐ **WARNING!** Ensure that the cut-off machine is unplugged from the power supply before attempting to change the cutting blade.
- 5.1 **IMPORTANT!** Cutting blades used with this machine shall be of an adequate speed rating and suitable for the task in hand.  
Order from your dealer quoting model no. SM355B.98
- 5.1.1 Before using a cutting blade ensure that there are no fissures or cracks in it. Once mounted on the cut-off machine, test the blade before use by facing the cut-off machine in a safe direction (turned away from yourself, others and vulnerable items) and run it for a short time.
- 5.2. **REMOVING AND INSTALLING CUTTING BLADES (Refer to figs. 5 & 6)**
- NOTE:** Removing and installing blades is only to be undertaken by competent persons.
- 5.2.1 Lift the arm into the up position.
- 5.2.2 Loosen the two hex screws to allow the blade access cover to be moved to the right and removed.
- 5.2.3 Pull the blade catch down and to the right and turn the blade using a 8mm hex key until the catch engages and prevents the blade from turning.
- 5.2.4 Keep the blade catch engaged and undo the blade hex screw anticlockwise.
- 5.2.5 Push back the blade guard and undo the hex screw to remove the blade, take care to note the orientation and position of the flanges and washers. Fit the new blade, assembly is the reverse of the above instructions.
- NOTE:** Take care to not overtighten the blade hex screw.

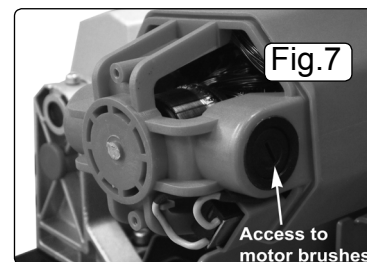
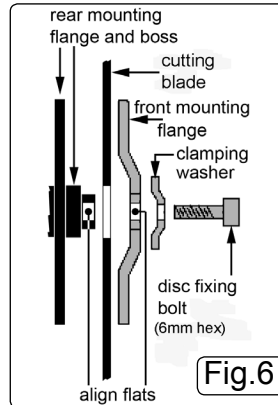
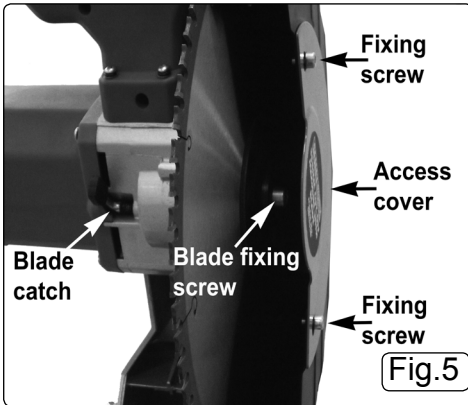

## 6. MAINTENANCE

- ☐ **WARNING!** Ensure that the cut-off machine is unplugged from the power supply before attempting any maintenance.
- 6.1 Regularly clean the dust which accumulates inside the protective guard and on the external parts.
- 6.2 Periodically clean and oil the vice screw.
- 6.3 Change the cutting blade when it is worn and/or does not operate efficiently.
- 6.4 Before each use, check for obvious signs of damage to the machine. Also check for loose screws and other moving parts, incorrectly mounted or misaligned parts and any other factors that might create an unsafe working environment.
- ☐ **WARNING!** Should excessive noise or vibration occur, cease use immediately. Turn off machine and disconnect from power supply. Do not use the machine again until the problem has been fully resolved.
- 6.5. **CHANGING THE MOTOR BRUSHES.**  
The motor brushes should be checked periodically for wear and renewed when worn down or pitted. The brushes can be accessed either side of the motor casing as seen in fig.7.
- 6.5.1 Unscrew the plastic covers and withdraw the brush assemblies for inspection.
- 6.5.2 Insert the new brush into the keyway. Place the plastic cap over the head of the brush assembly and press the spring downwards ensuring that the tabs on either side of the brush head enter the same keyway as the brush. Screw the caps back into position.

Parts support is available for this product. To obtain a parts listing and/or diagram, please log on to [www.sealey.co.uk](http://www.sealey.co.uk), email [sales@sealey.co.uk](mailto:sales@sealey.co.uk) or phone 01284 757500.



### Environmental Protection.

Recycle unwanted materials instead of disposing of them as waste. All tools, accessories and packaging should be sorted, taken to a recycle centre and disposed of in a manner which is compatible with the environment.



### WEEE Regulations.

Dispose of this product at the end of its working life in compliance with the EU Directive on Waste Electrical and Electronic Equipment. When the product is no longer required, it must be disposed of in an environmentally protective way. Contact your local solid waste authority for recycling information.

**NOTE:** It is our policy to continually improve products and as such we reserve the right to alter data, specifications and component parts without prior notice.

**IMPORTANT:** No liability is accepted for incorrect use of this product.

**WARRANTY:** Guarantee is 12 months from purchase date, proof of which will be required for any claim.

**INFORMATION:** For a copy of our catalogue and latest promotions call us on 01284 757525 and leave your full name, address and postcode.



Sole UK Distributor, Sealey Group,  
Kempston Way, Suffolk Business Park,  
Bury St. Edmunds, Suffolk, IP32 7AR



01284 757500

01284 703534



[www.sealey.co.uk](http://www.sealey.co.uk)

[sales@sealey.co.uk](mailto:sales@sealey.co.uk)